

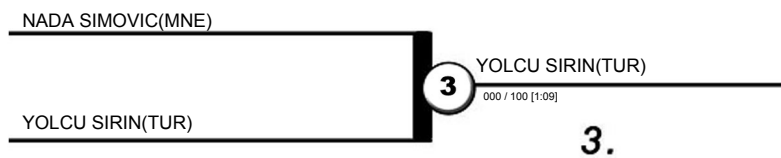

40 KG
4 Judoka

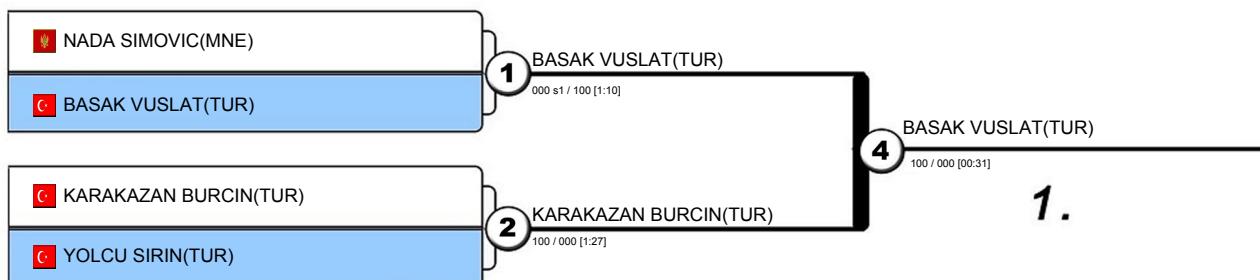

Results
Resultat / Platzierungen

1. BASAK VUSLAT(TUR)
2. KARAKAZAN BURCIN(TUR)
3. YOLCU SIRIN(TUR)
3. NADA SIMOVIC(MNE)



BALKAN JUDO ASSOCIATION
BALKAN JUDO CHAMPIONSHIP For CADETS (U18)
 May 09 - 10 , 2026 - BUDVA, MONTENEGRO

44 KG
 7 Judoka

POOL A

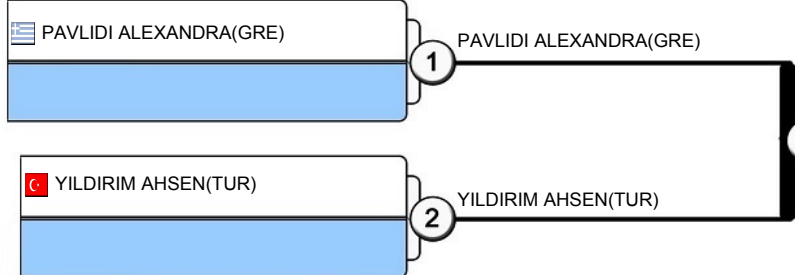

POOL B

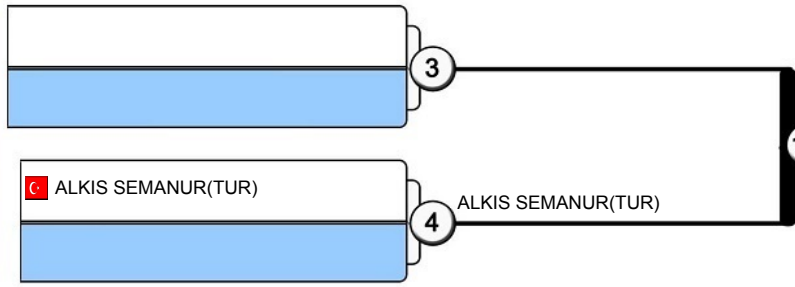

POOL C

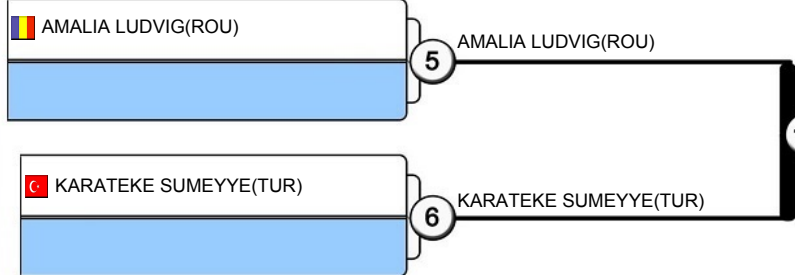

POOL D

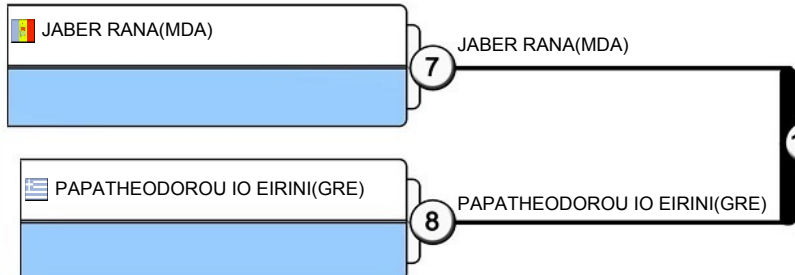

9 YILDIRIM AHSEN(TUR)
000 s1 / 101 [3:55]
Pool A - Winner
 Vainqueur / Sieger

10 ALKIS SEMANUR(TUR)
Pool B - Winner
 Vainqueur / Sieger

11 KARATEKE SUMEYYE(TUR)
000 / 110 [1:52]
Pool C - Winner
 Vainqueur / Sieger

12 JABER RANA(MDA)
100 / 000 [1:41]
Pool D - Winner
 Vainqueur / Sieger

17 YILDIRIM AHSEN(TUR)
010 / 000 [04:00]

23 YILDIRIM AHSEN(TUR)
111 / 000 s1 [1:59]

18 KARATEKE SUMEYYE(TUR)
110 / 000 [00:49]

- Results**
 Resultat / Platzierungen
1. YILDIRIM AHSEN(TUR)
 2. KARATEKE SUMEYYE(TUR)
 3. PAVLIDI ALEXANDRA(GRE)
 3. ALKIS SEMANUR(TUR)
 5. JABER RANA(MDA)
 5. AMALIA LUDVIG(ROU)
 - 7.
 7. PAPATHEODOROU IO EIRINI(GRE)

Repechage / Trostrunde

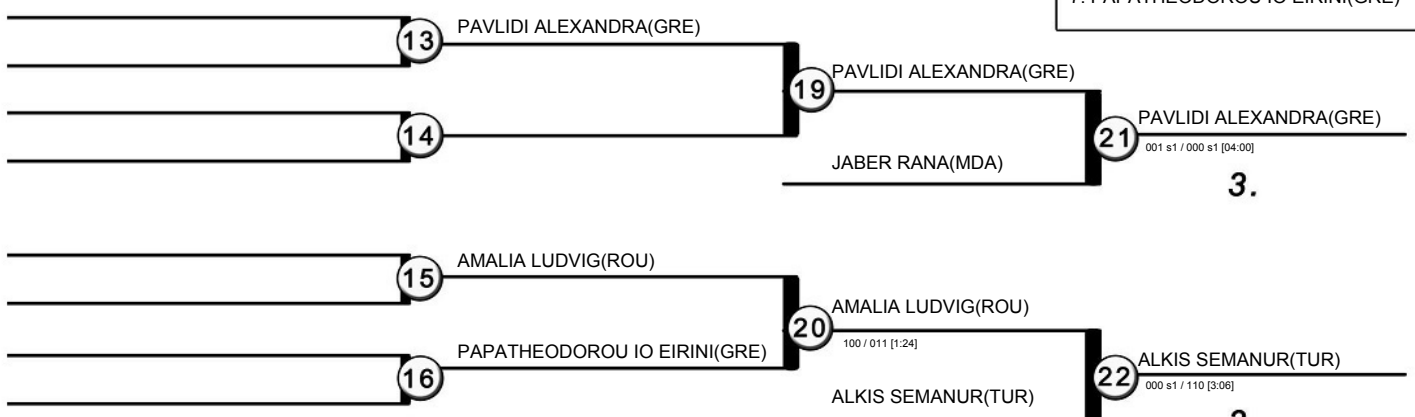



BALKAN JUDO ASSOCIATION
BALKAN JUDO CHAMPIONSHIP For CADETS (U18)
 May 09 - 10 , 2026 - BUDVA, MONTENEGRO

48 KG
 13 Judoka

POOL A

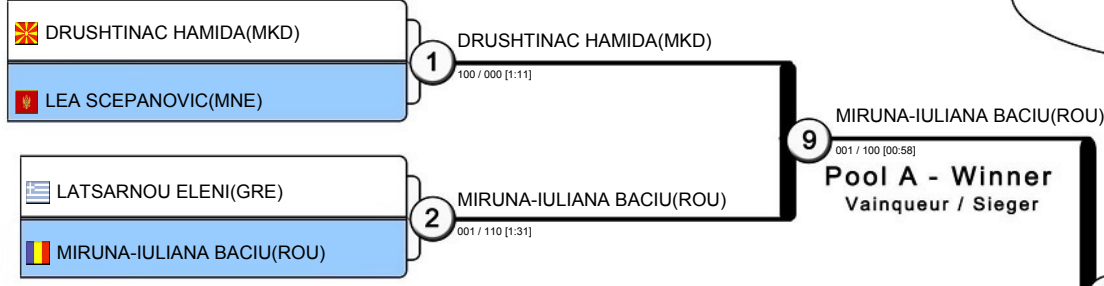

POOL B

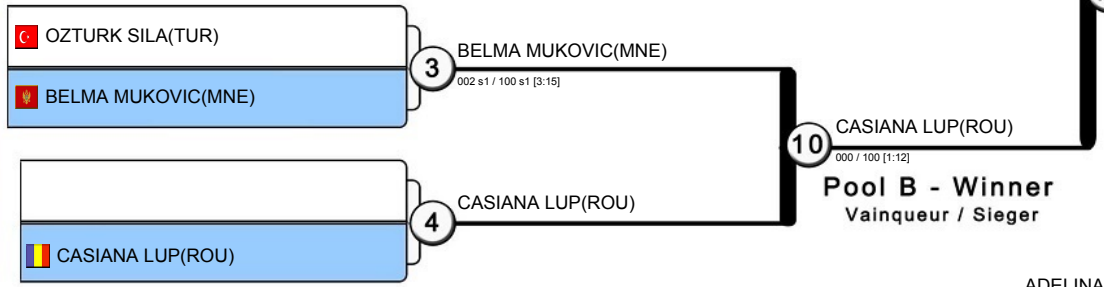

POOL C

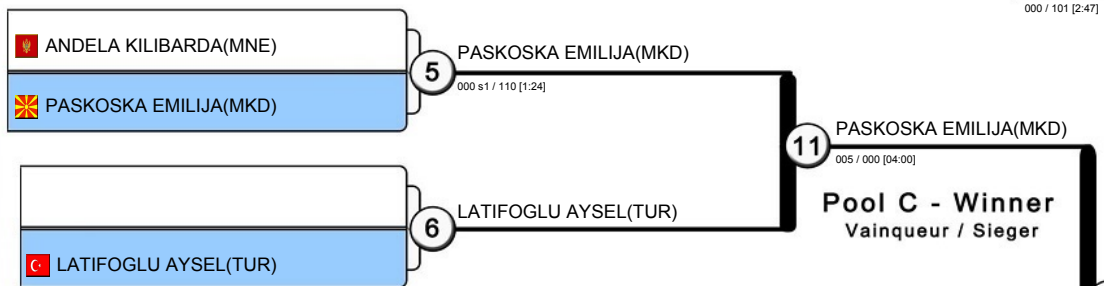

POOL D

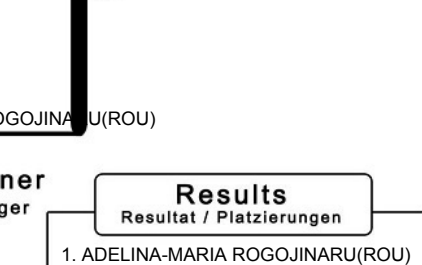
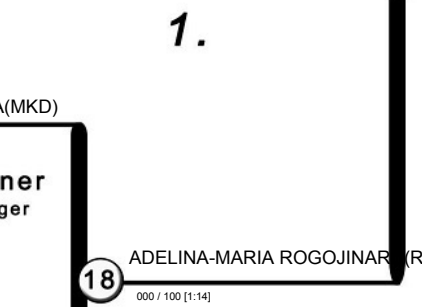
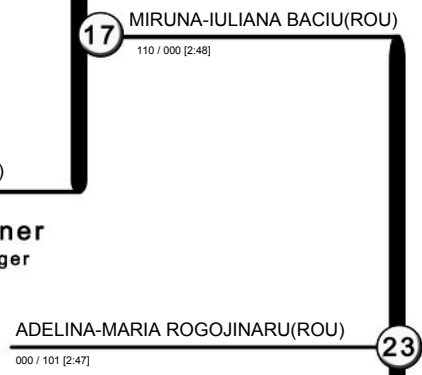
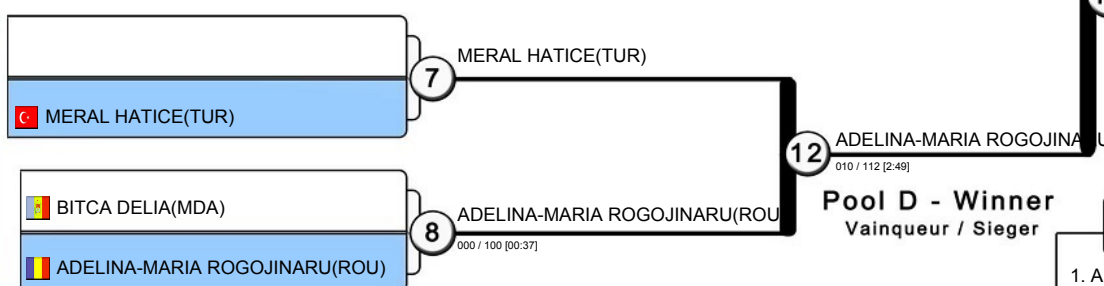

- Results**
 Resultat / Platzierungen
1. ADELINA-MARIA ROGOJINARU(ROU)
 2. MIRUNA-IULIANA BACIU(ROU)
 3. DRUSHTINAC HAMIDA(MKD)
 3. MERAL HATICE(TUR)
 5. PASKOSKA EMILIJA(MKD)
 5. CASIANA LUP(ROU)
 7. BELMA MUKOVIC(MNE)
 7. LATIFOGLU AYSEL(TUR)

Repechage / Trostrunde

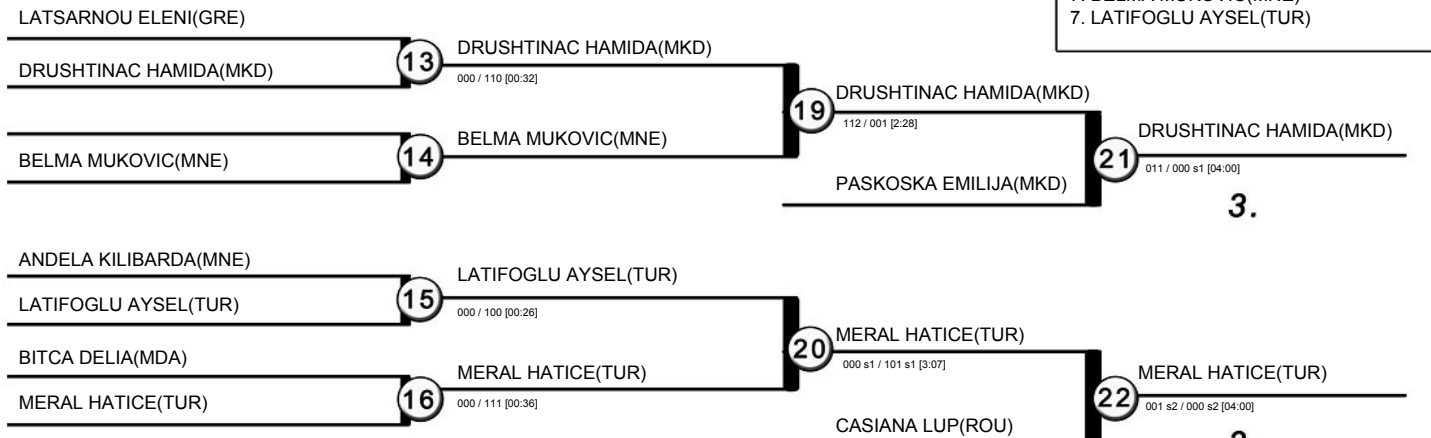



BALKAN JUDO ASSOCIATION

BALKAN JUDO CHAMPIONSHIP For CADETS (U18)

May 09 - 10, 2026 - BUDVA, MONTENEGRO

52 KG
18 Judoka

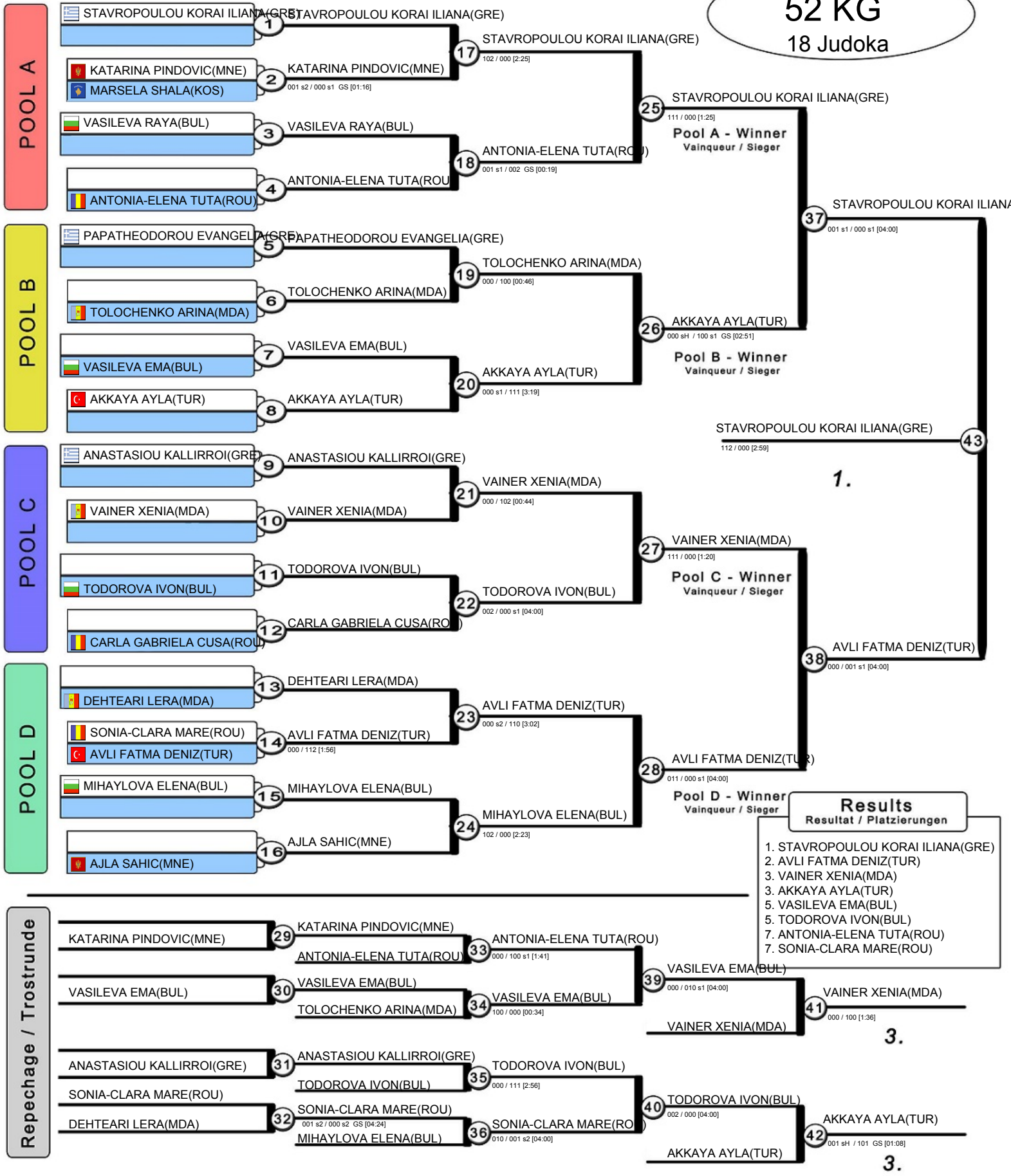



BALKAN JUDO ASSOCIATION

BALKAN JUDO CHAMPIONSHIP For CADETS (U18)

May 09 - 10, 2026 - BUDVA, MONTENEGRO

57 KG

24 Judoka

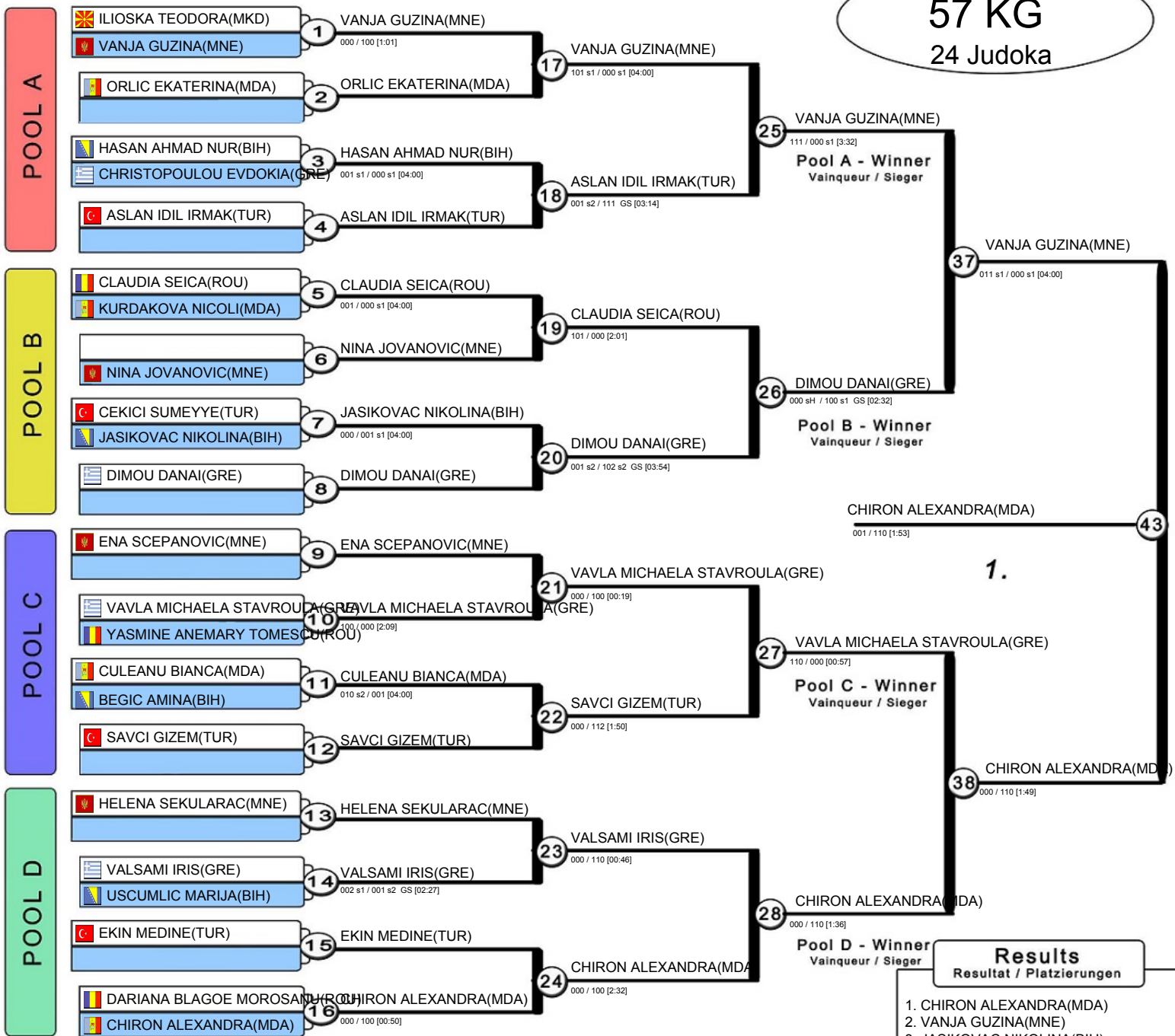

Results

Resultat / Platzierungen

1. CHIRON ALEXANDRA (MDA)
2. VANJA GUZINA (MNE)
3. JASIKOVAC NIKOLINA (BIH)
3. DIMOU DANAI (GRE)
5. VAVLA MICHAELA STAVROULA (GRE)
5. VALSAMI IRIS (GRE)
7. ASLAN IDIL IRMAK (TUR)
7. SAVCI GIZEM (TUR)

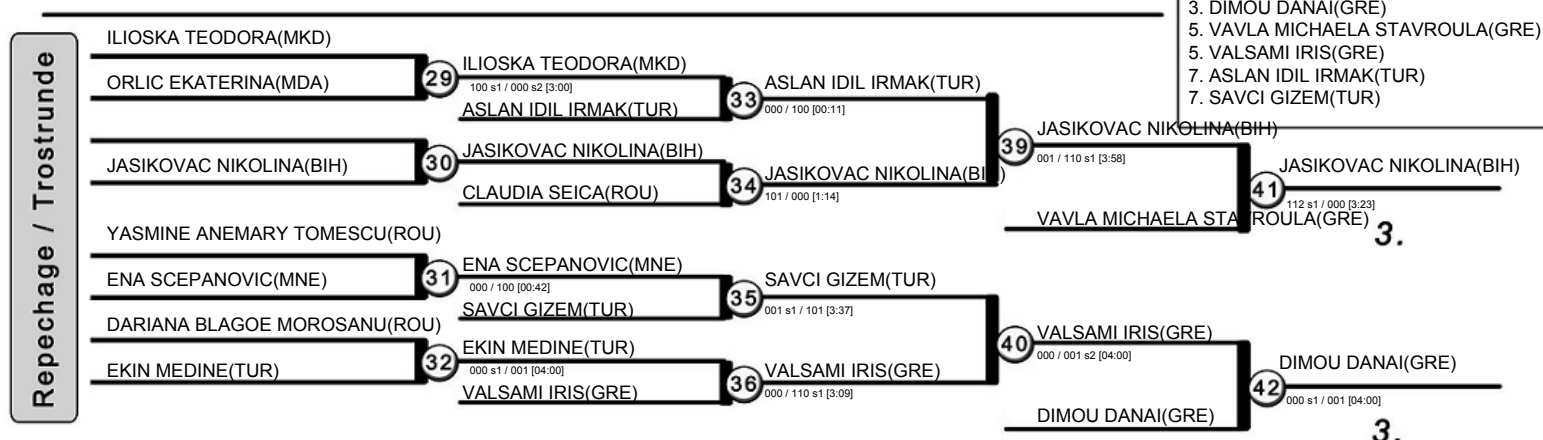



BALKAN JUDO ASSOCIATION

BALKAN JUDO CHAMPIONSHIP For CADETS (U18)

May 09 - 10, 2026 - BUDVA, MONTENEGRO

63 KG

22 Judoka

POOL A

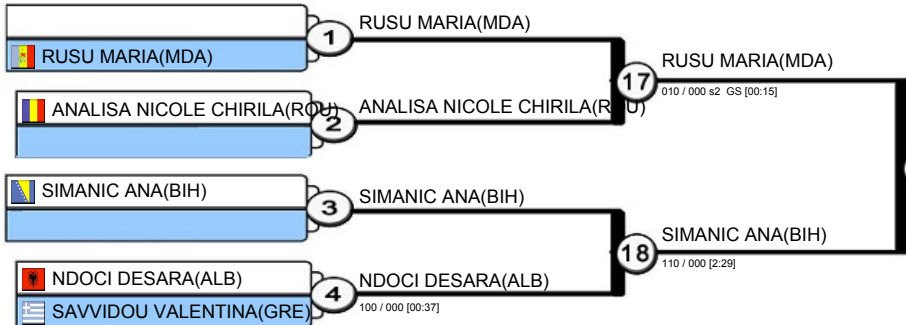

Pool A - Winner
Vainqueur / Sieger

POOL B

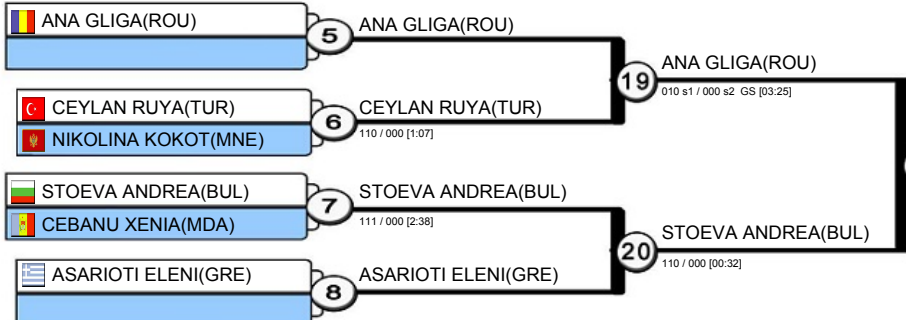

Pool B - Winner
Vainqueur / Sieger

POOL C

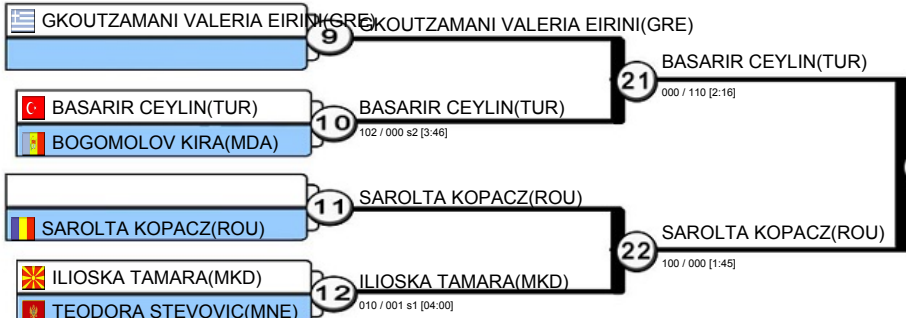

Pool C - Winner
Vainqueur / Sieger

POOL D

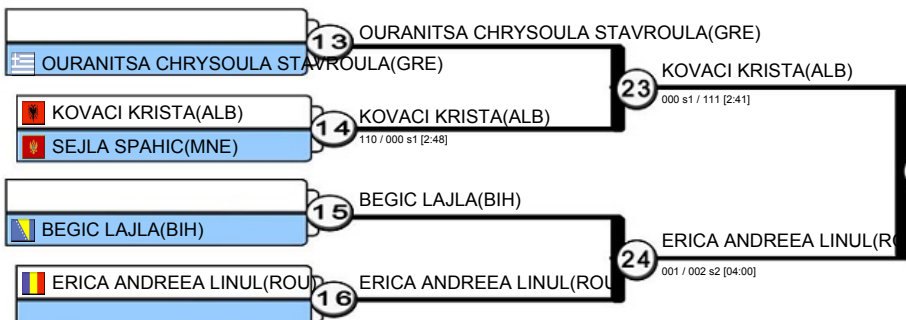

Pool D - Winner
Vainqueur / Sieger

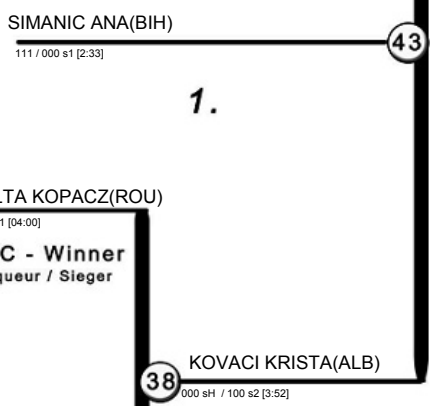

Results
Resultat / Platzierungen

1. SIMANIC ANA(BIH)
2. KOVACI KRISTA(ALB)
3. SAROLTA KOPACZ(ROU)
3. ANA GLIGA(ROU)
5. STOEVA ANDREA(BUL)
7. NDOCI DESARA(ALB)
7. BASARIR CEYLIN(TUR)

Repechage / Trostrunde

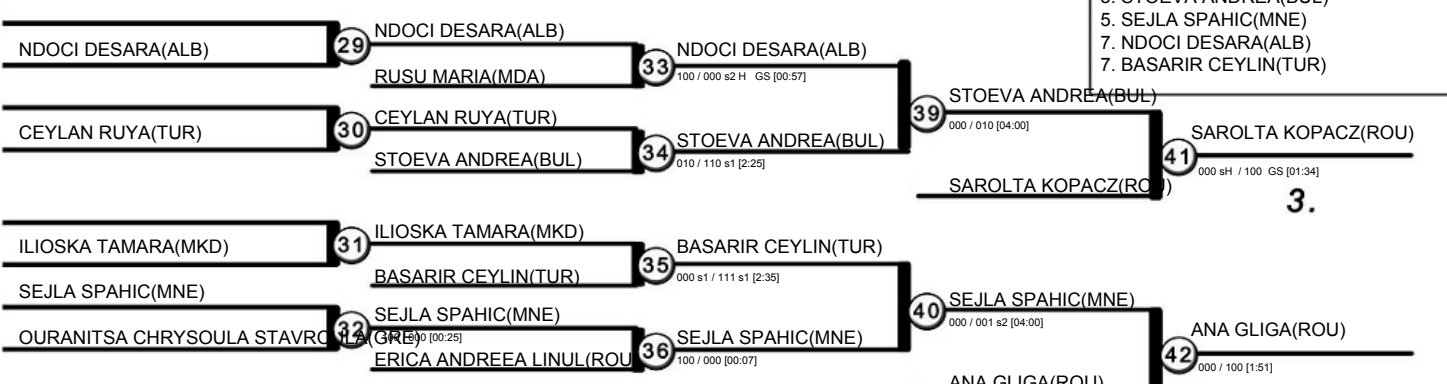



BALKAN JUDO ASSOCIATION
BALKAN JUDO CHAMPIONSHIP For CADETS (U18)
 May 09 - 10, 2026 - BUDVA, MONTENEGRO

70 KG
 19 Judoka

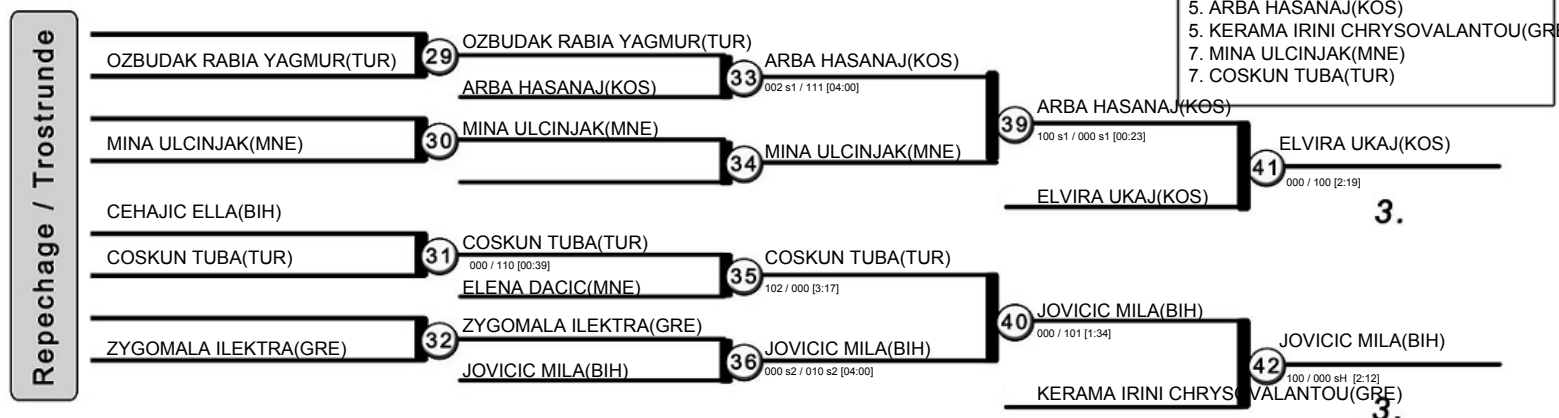
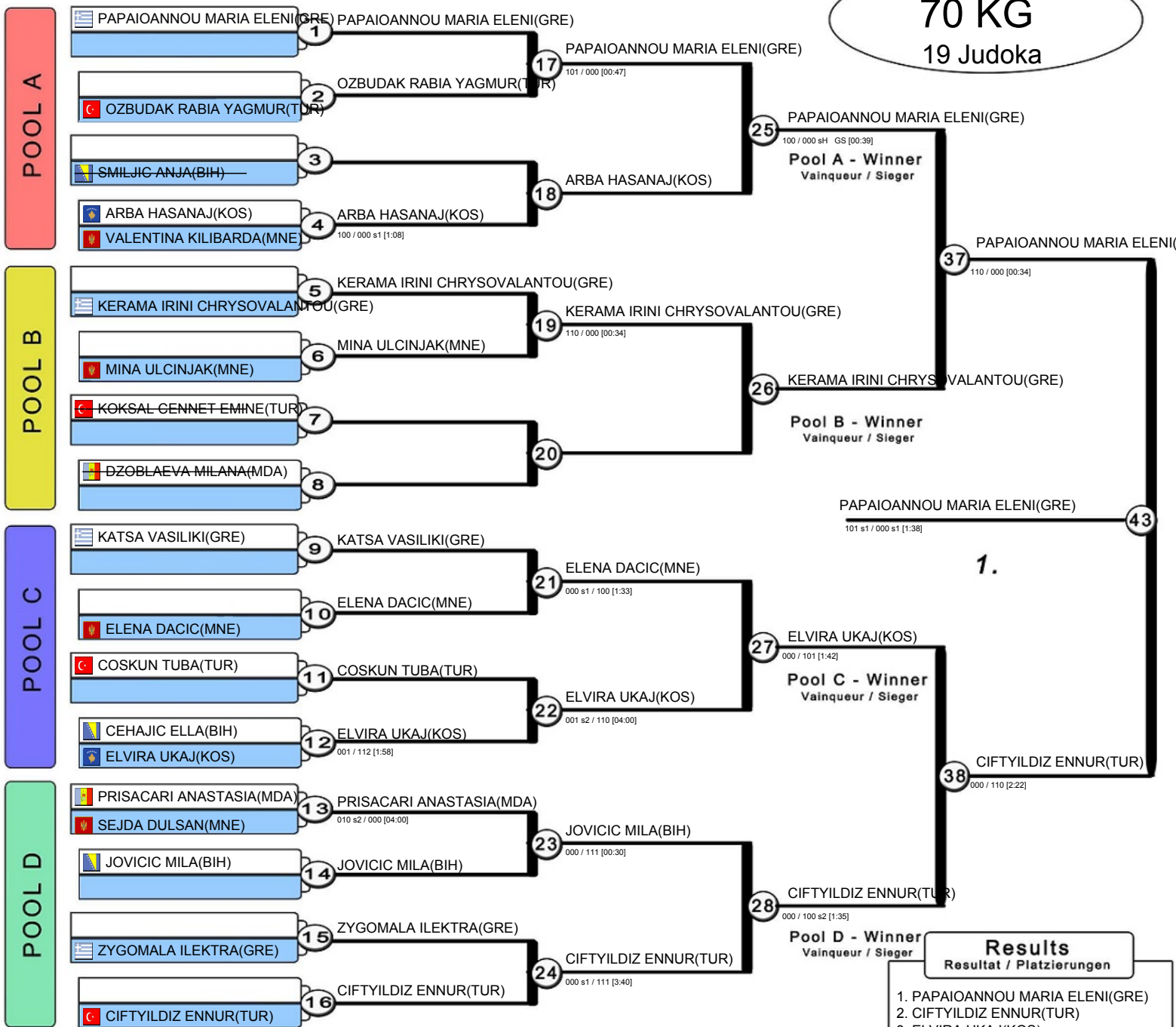



BALKAN JUDO ASSOCIATION
BALKAN JUDO CHAMPIONSHIP For CADETS (U18)
 May 09 - 10, 2026 - BUDVA, MONTENEGRO

+70 KG
 17 Judoka

POOL A

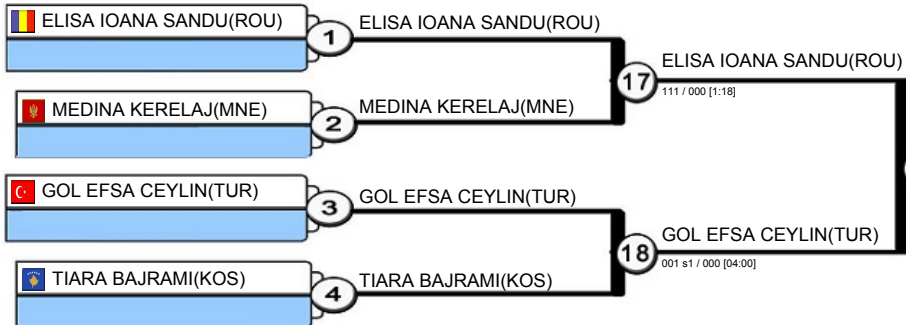

POOL B

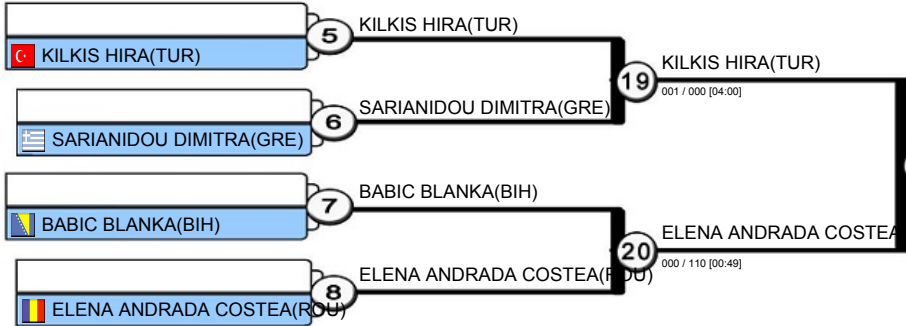

POOL C

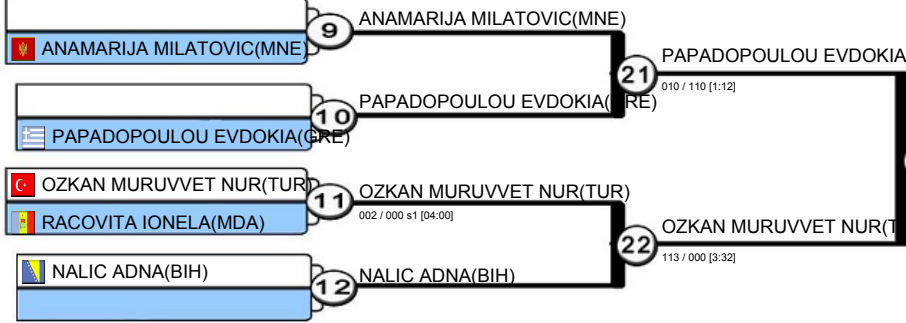

POOL D

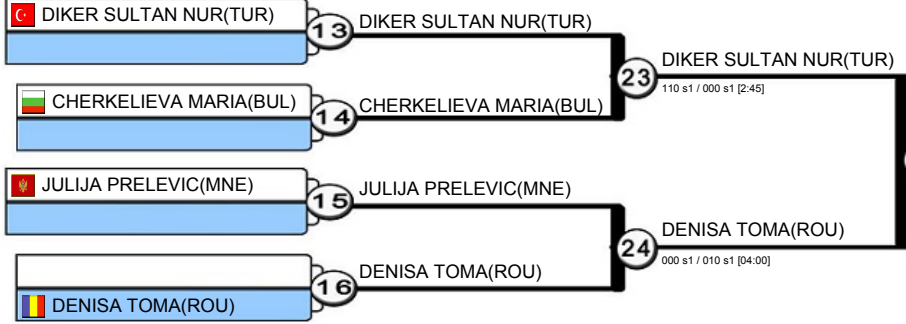

Repechage / Trostrunde

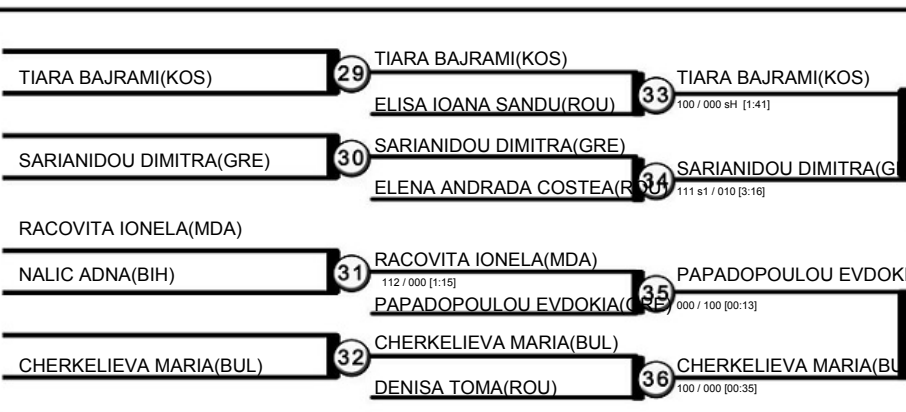

Results
 Resultat / Platzierungen

- OZKAN MURUVVET NUR(TUR)
- GOL EFSA CEYLIN(TUR)
- DIKER SULTAN NUR(TUR)
- KILKIS HIRA(TUR)
- SARIANIDOU DIMITRA(GRE)
- CHERKELIEVA MARIA(BUL)
- TIARA BAJRAMI(KOS)
- PAPAPOULOU EVDOKIA(GRE)



BALKAN JUDO ASSOCIATION
BALKAN JUDO CHAMPIONSHIP For CADETS (U18)
 May 09 - 10 , 2026 - BUDVA, MONTENEGRO

50 KG
 20 Judoka

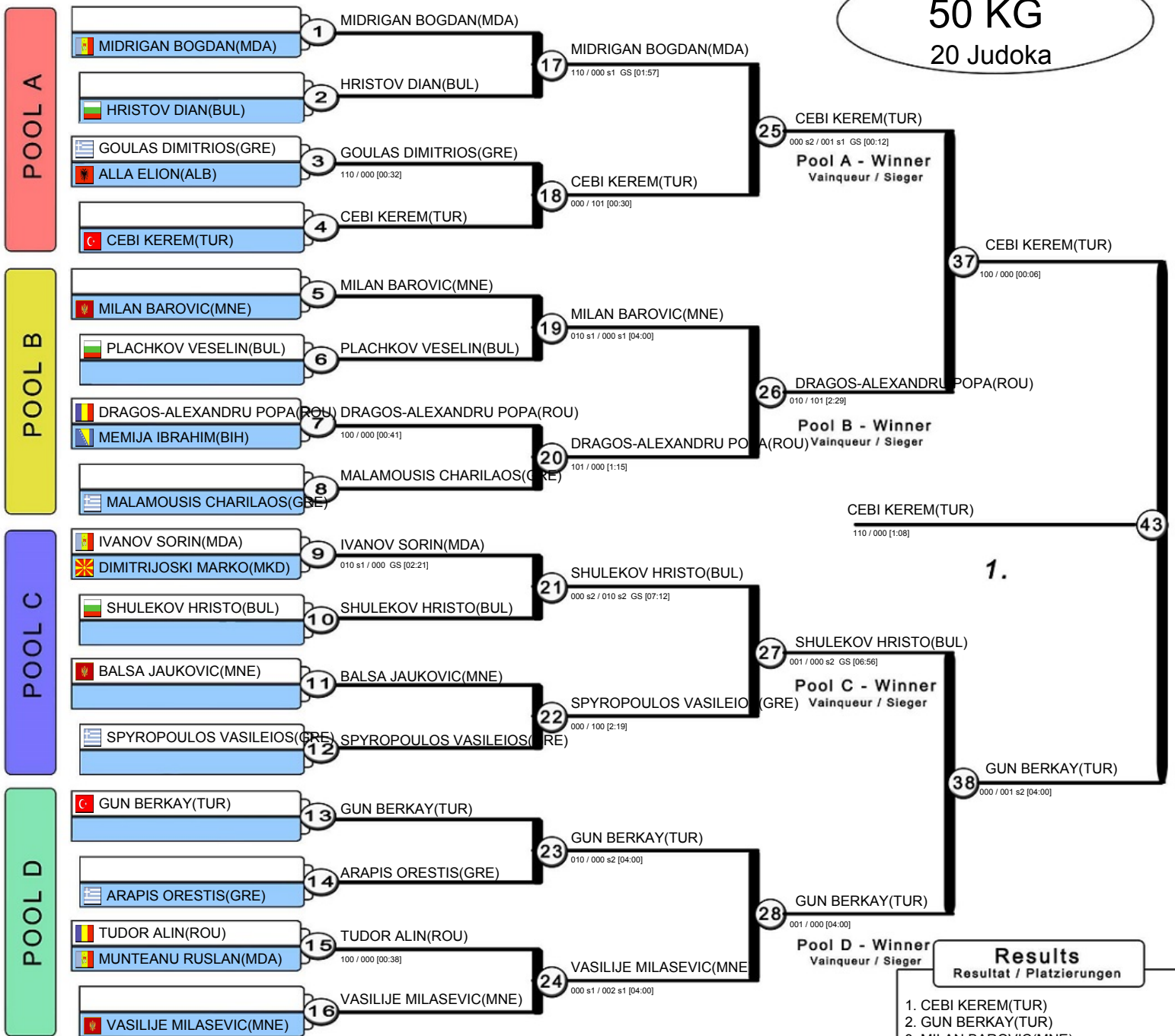



BALKAN JUDO ASSOCIATION

BALKAN JUDO CHAMPIONSHIP For CADETS (U18)

May 09 - 10, 2026 - BUDVA, MONTENEGRO

55 KG
23 Judoka

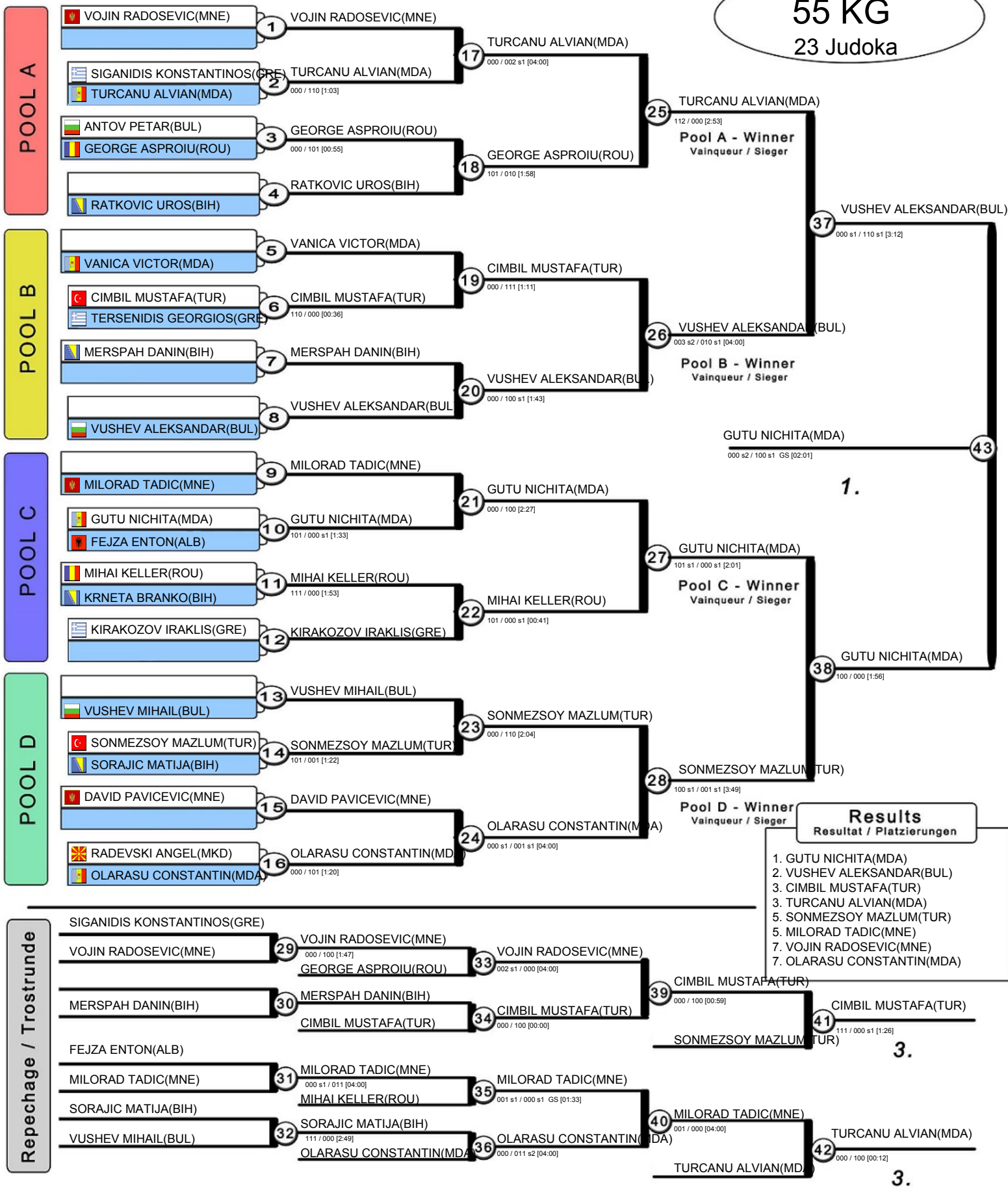

Results
Resultat / Platzierungen

- GUTU NICHITA(MDA)
- VUSHEV ALEKSANDAR(BUL)
- CIMBIL MUSTAFA(TUR)
- TURCANU ALVIAN(MDA)
- SONMEZSOY MAZLUM(TUR)
- VOJIN RADOSEVIC(MNE)
- OLARASU CONSTANTIN(MDA)



BALKAN JUDO ASSOCIATION

BALKAN JUDO CHAMPIONSHIP For CADETS (U18)

May 09 - 10, 2026 - BUDVA, MONTENEGRO

60 KG
28 Judoka

POOL A

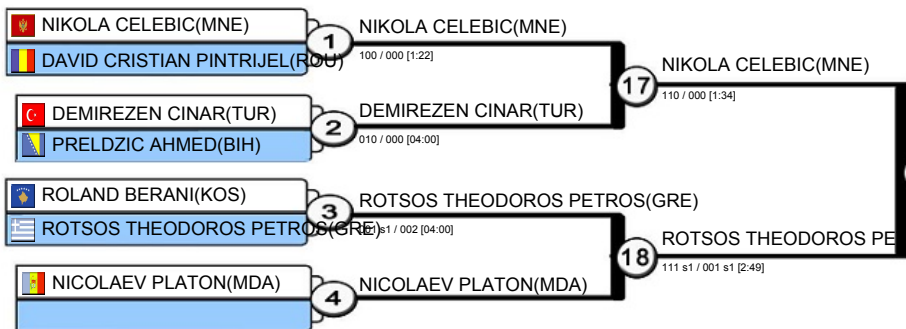

POOL B

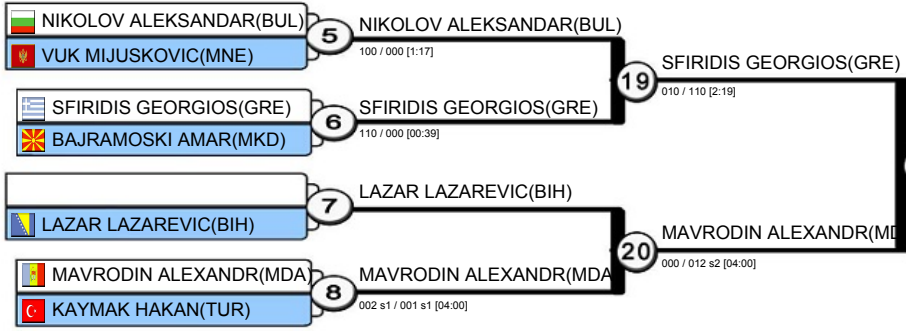

POOL C

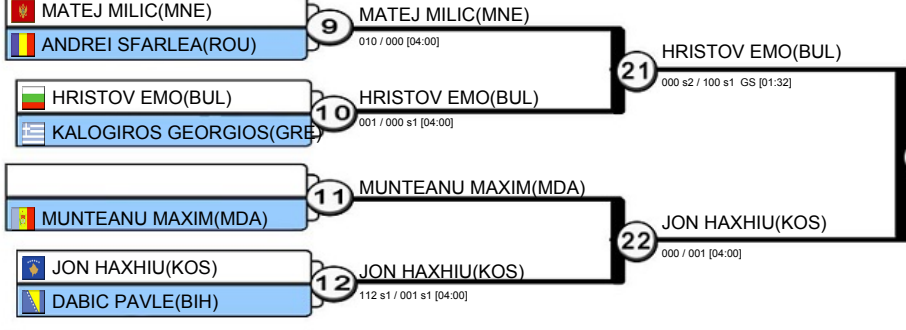

POOL D

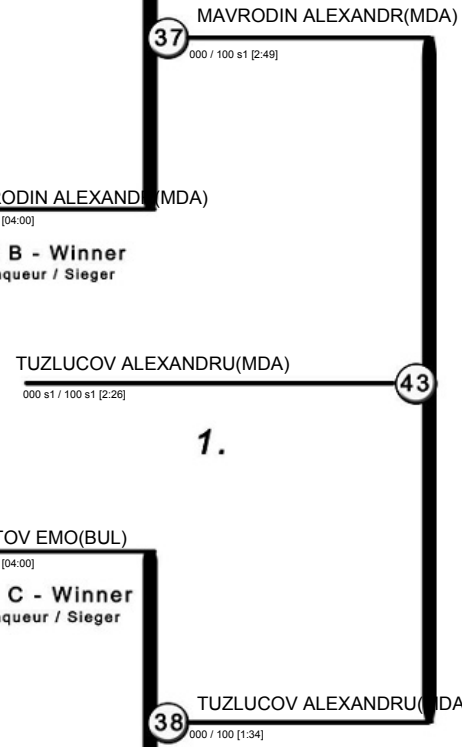
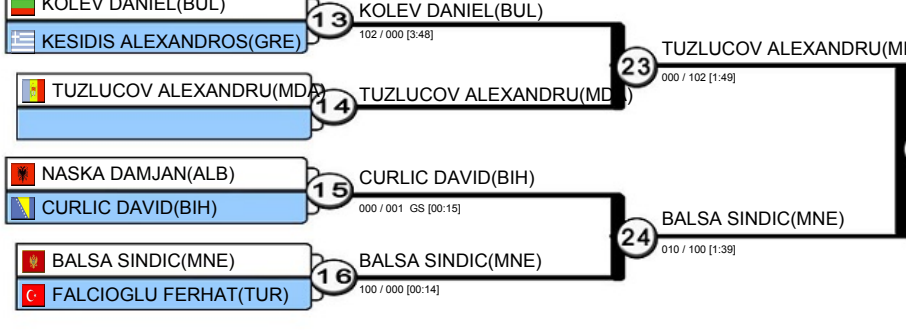

Repechage / Trostrunde

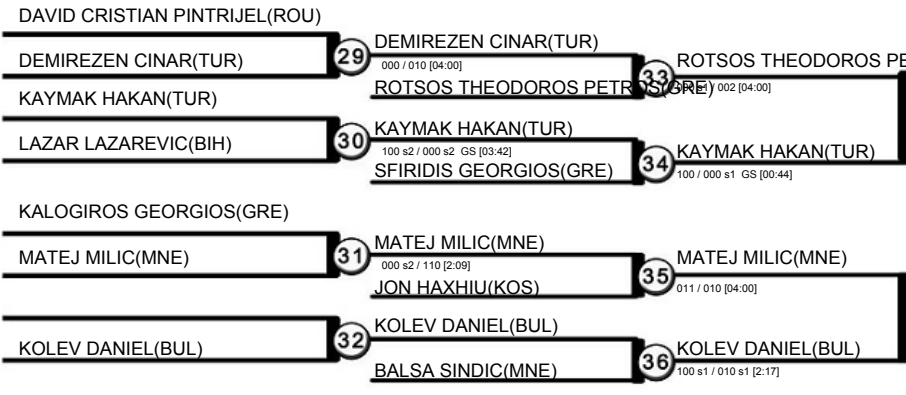

Results
Resultat / Platzierungen

1. TUZLUCOV ALEXANDRU(MDA)
2. MAVRODIN ALEXANDR(MDA)
3. HRISTOV EMO(BUL)
3. NIKOLA CELEBIC(MNE)
5. ROTSOS THEODOROS PETROS(GRE)
7. KAYMAK HAKAN(TUR)
7. MATEJ MILIC(MNE)



BALKAN JUDO ASSOCIATION

BALKAN JUDO CHAMPIONSHIP For CADETS (U18)

May 09 - 10, 2026 - BUDVA, MONTENEGRO

66 KG

28 Judoka

POOL A

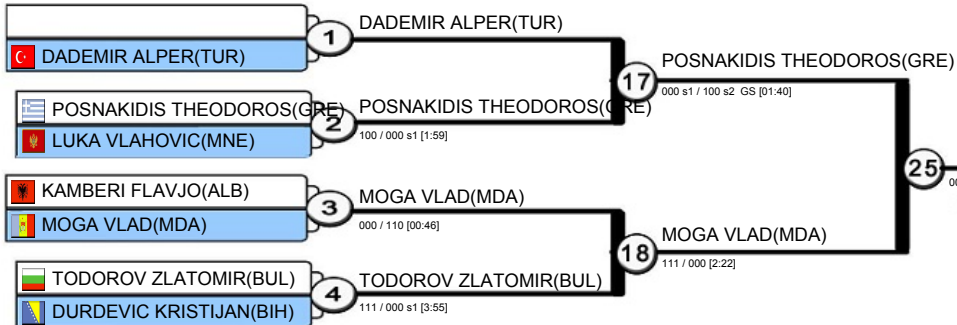

Pool A - Winner
Vainqueur / Sieger

POOL B

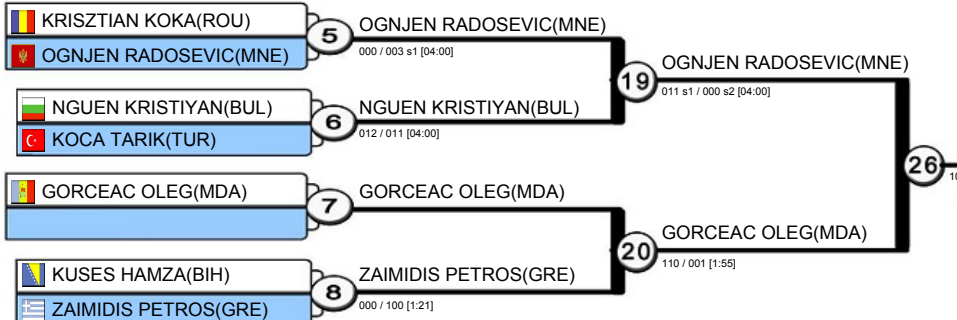

Pool B - Winner
Vainqueur / Sieger

POOL C

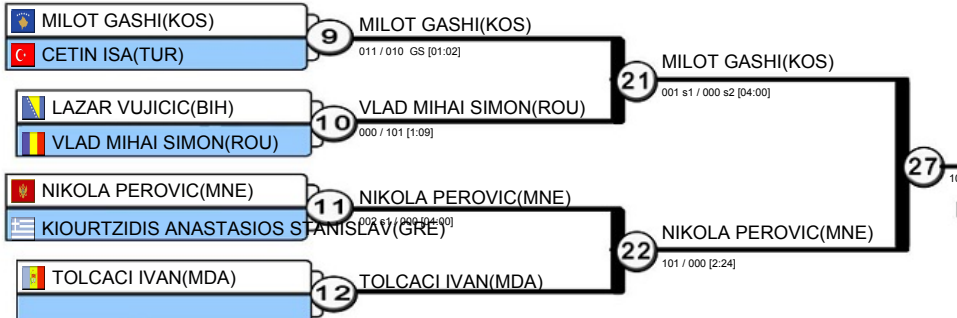

Pool C - Winner
Vainqueur / Sieger

POOL D

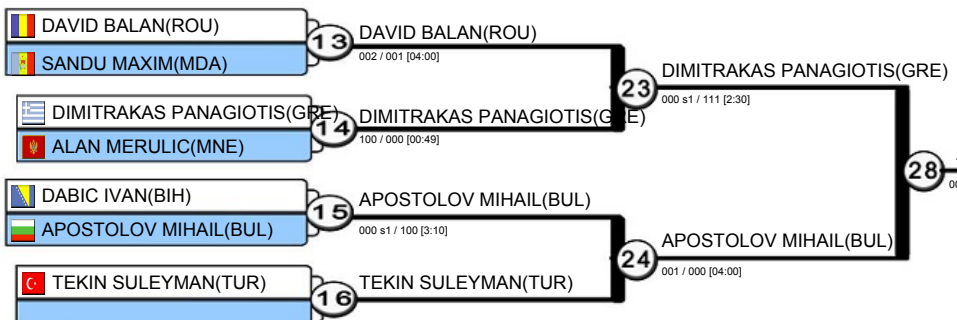

Pool D - Winner
Vainqueur / Sieger

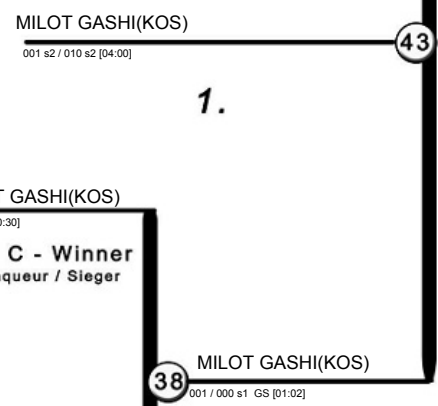

1.

Results
Resultat / Platzierungen

1. MILOT GASHI(KOS)
2. MOGA VLAD(MDA)
3. APOSTOLOV MIHAIL(BUL)
5. OGNJEN RADOSEVIC(MNE)
5. NGUEN KRISTIYAN(BUL)
5. NIKOLA PEROVIC(MNE)
7. POSNAKIDIS THEODOROS(GRE)
7. DIMITRAKAS PANAGIOTIS(GRE)

Repechage / Trostrunde

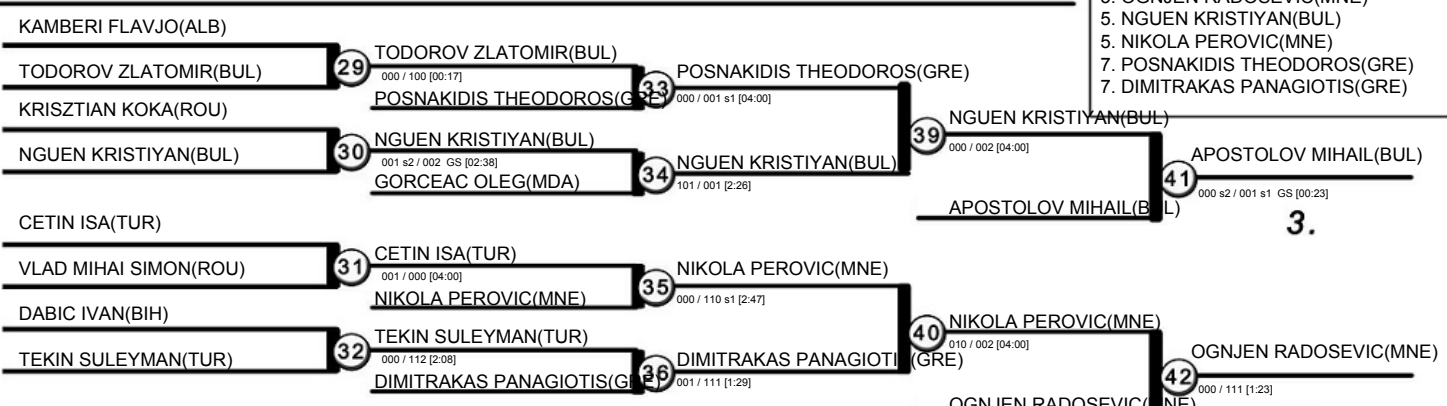

3.

3.



BALKAN JUDO ASSOCIATION
BALKAN JUDO CHAMPIONSHIP For CADETS (U18)
 May 09 - 10 , 2026 - BUDVA, MONTENEGRO

73 KG
 28 Judoka

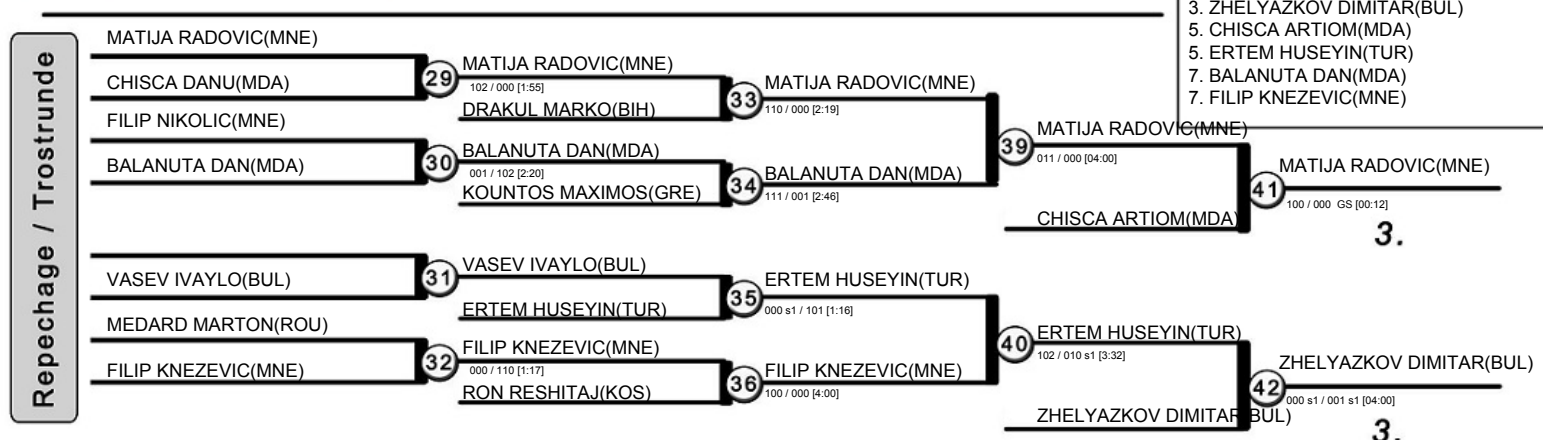
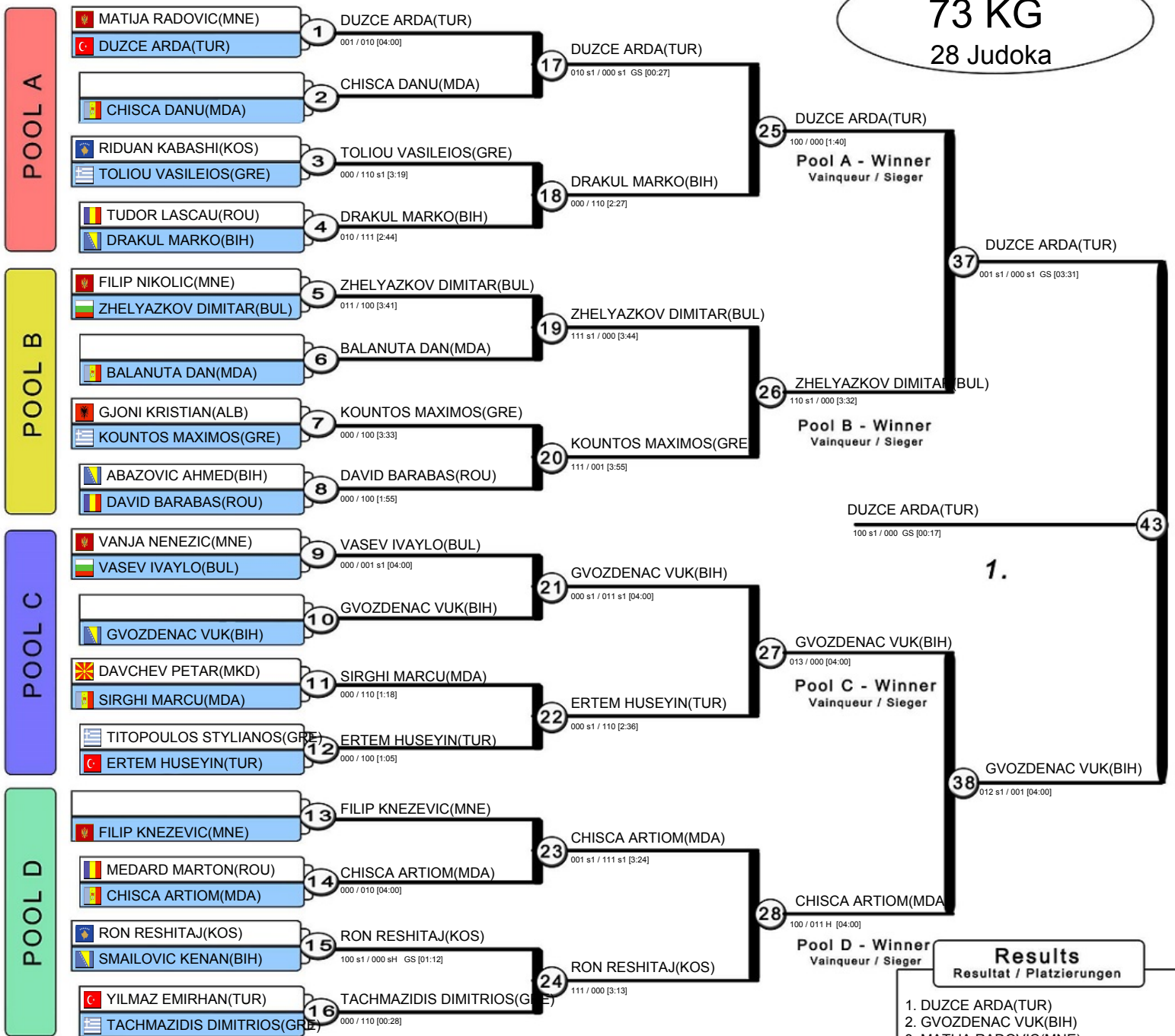



BALKAN JUDO ASSOCIATION
BALKAN JUDO CHAMPIONSHIP For CADETS (U18)
 May 09 - 10, 2026 - BUDVA, MONTENEGRO

81 KG
25 Judoka

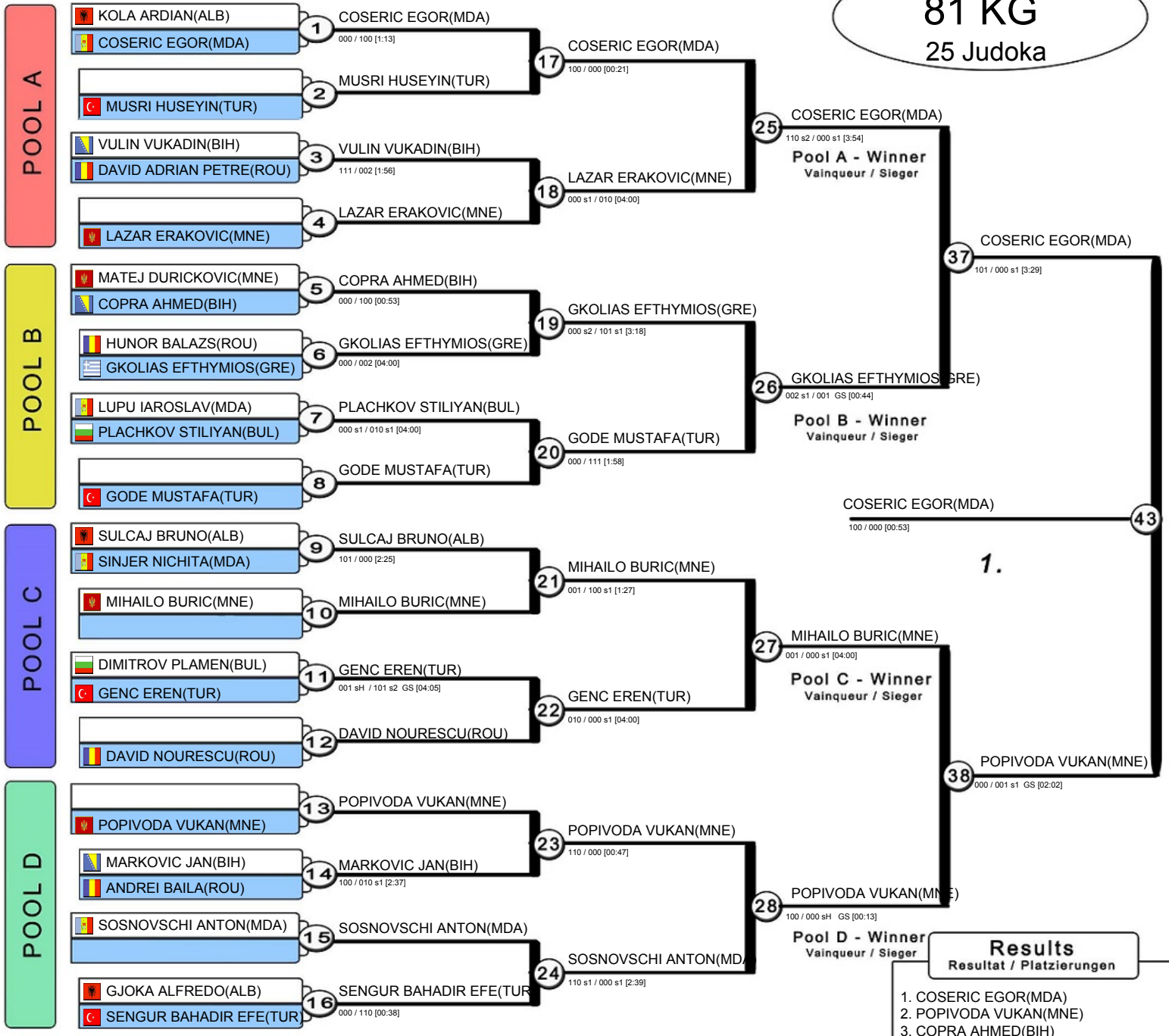

Results
 Resultat / Platzierungen

1. COSERIC EGOR(MDA)
2. POPIVODA VUKAN(MNE)
3. COPRA AHMED(BIH)
4. MIHAILO BURIC(MNE)
5. GENC EREN(TUR)
6. LAZAR ERAKOVIC(MNE)
7. MARKOVIC JAN(BIH)

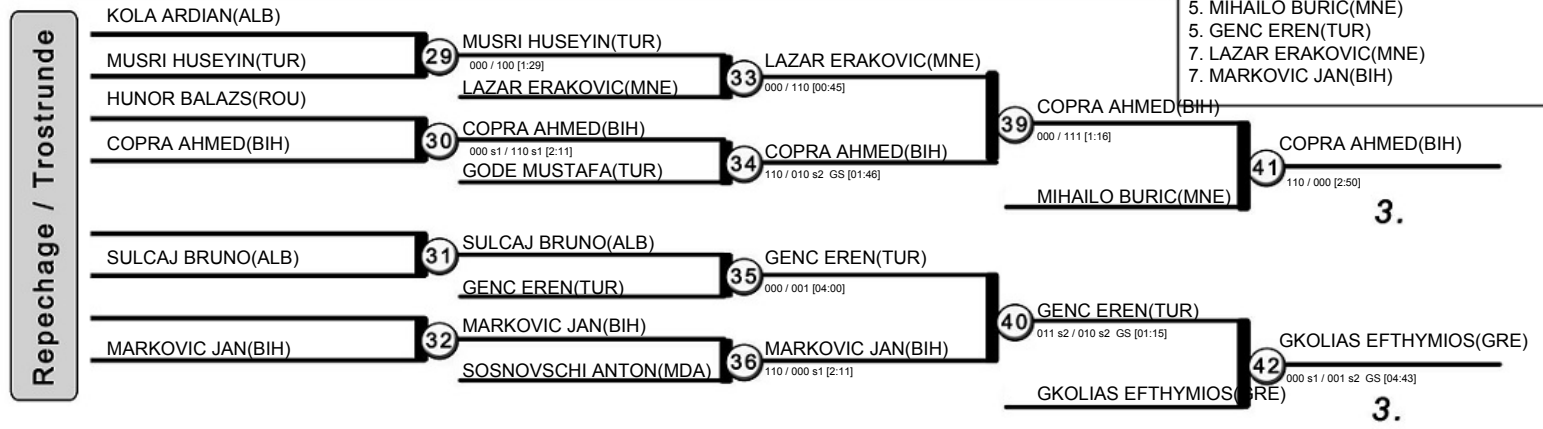



BALKAN JUDO ASSOCIATION
BALKAN JUDO CHAMPIONSHIP For CADETS (U18)
 May 09 - 10, 2026 - BUDVA, MONTENEGRO

90 KG
 19 Judoka

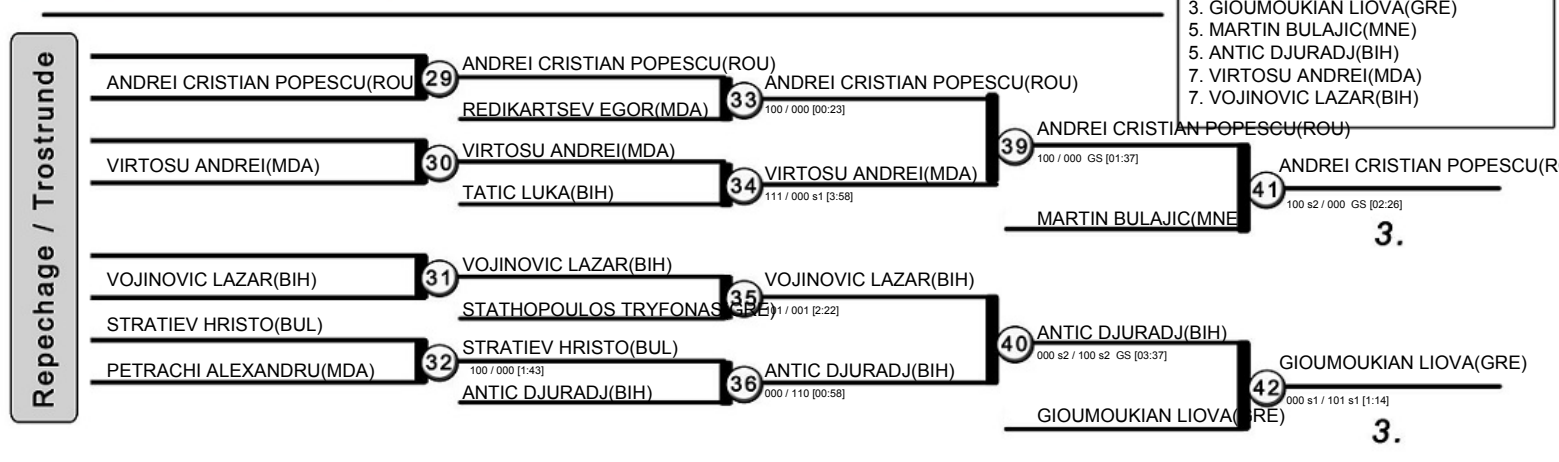
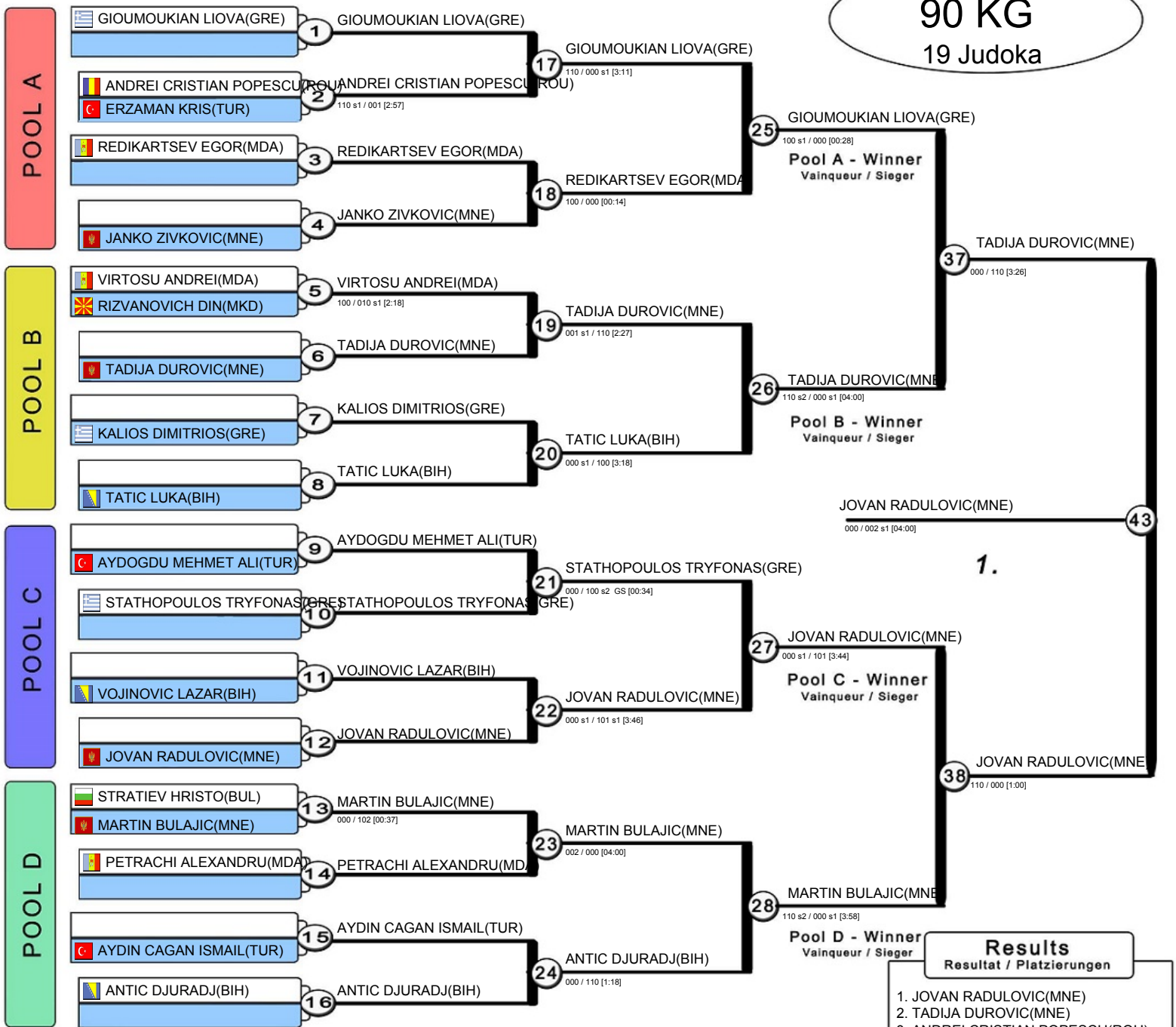



BALKAN JUDO ASSOCIATION

BALKAN JUDO CHAMPIONSHIP For CADETS (U18)

May 09 - 10, 2026 - BUDVA, MONTENEGRO

+90 KG
17 Judoka

POOL A

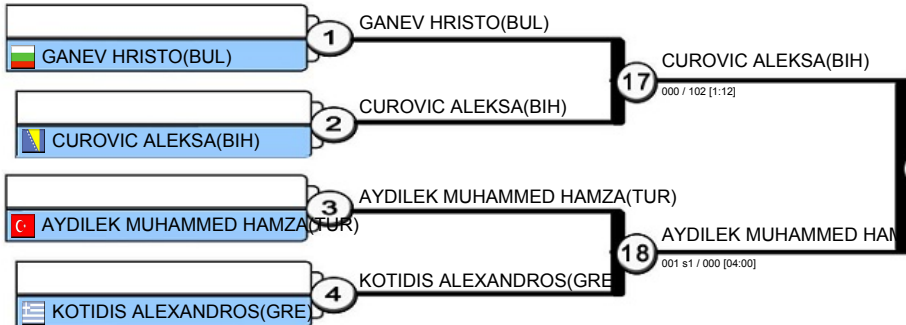

Pool A - Winner
Vainqueur / Sieger

POOL B

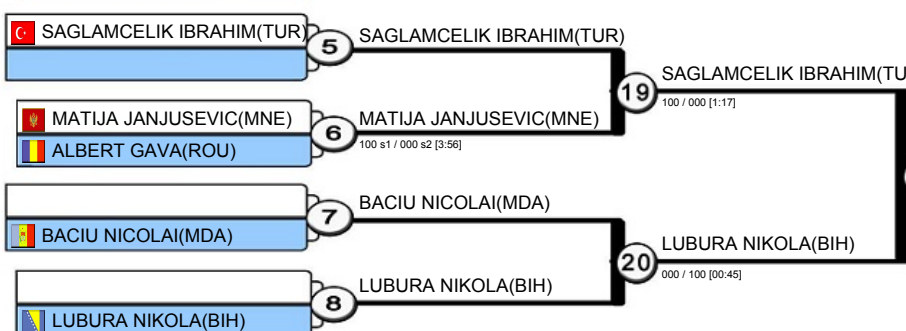

Pool B - Winner
Vainqueur / Sieger

POOL C

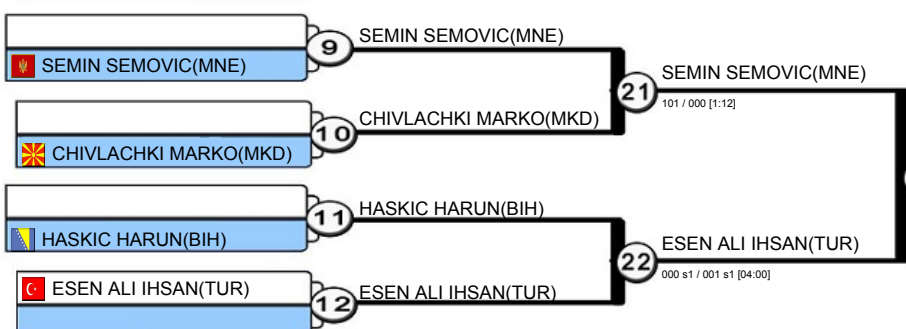

Pool C - Winner
Vainqueur / Sieger

POOL D

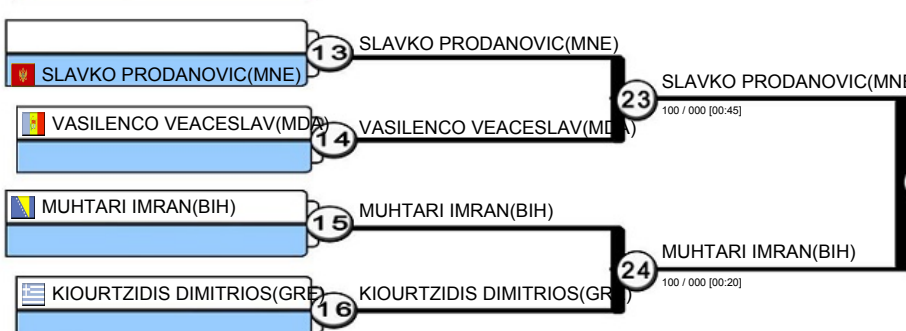

Pool D - Winner
Vainqueur / Sieger

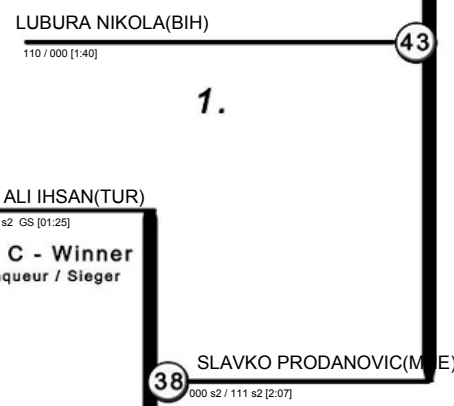

Results
Resultat / Platzierungen

1. LUBURA NIKOLA (BIH)
2. SLAVKO PRODANOVIC (MNE)
3. CUROVIC ALEKSA (BIH)
3. MUHTARI IMRAN (BIH)
5. ESEN ALI IHSAN (TUR)
7. SAGLAMCELIK IBRAHIM (TUR)
7. SEMIN SEMOVIC (MNE)

Repechage / Trostrunde



Pool A Winner
Vainqueur / Sieger

Pool B Winner
Vainqueur / Sieger

3. CUROVIC ALEKSA (BIH)
3. MUHTARI IMRAN (BIH)
3. AYDILEK MUHAMMED HAMZA (TUR)