

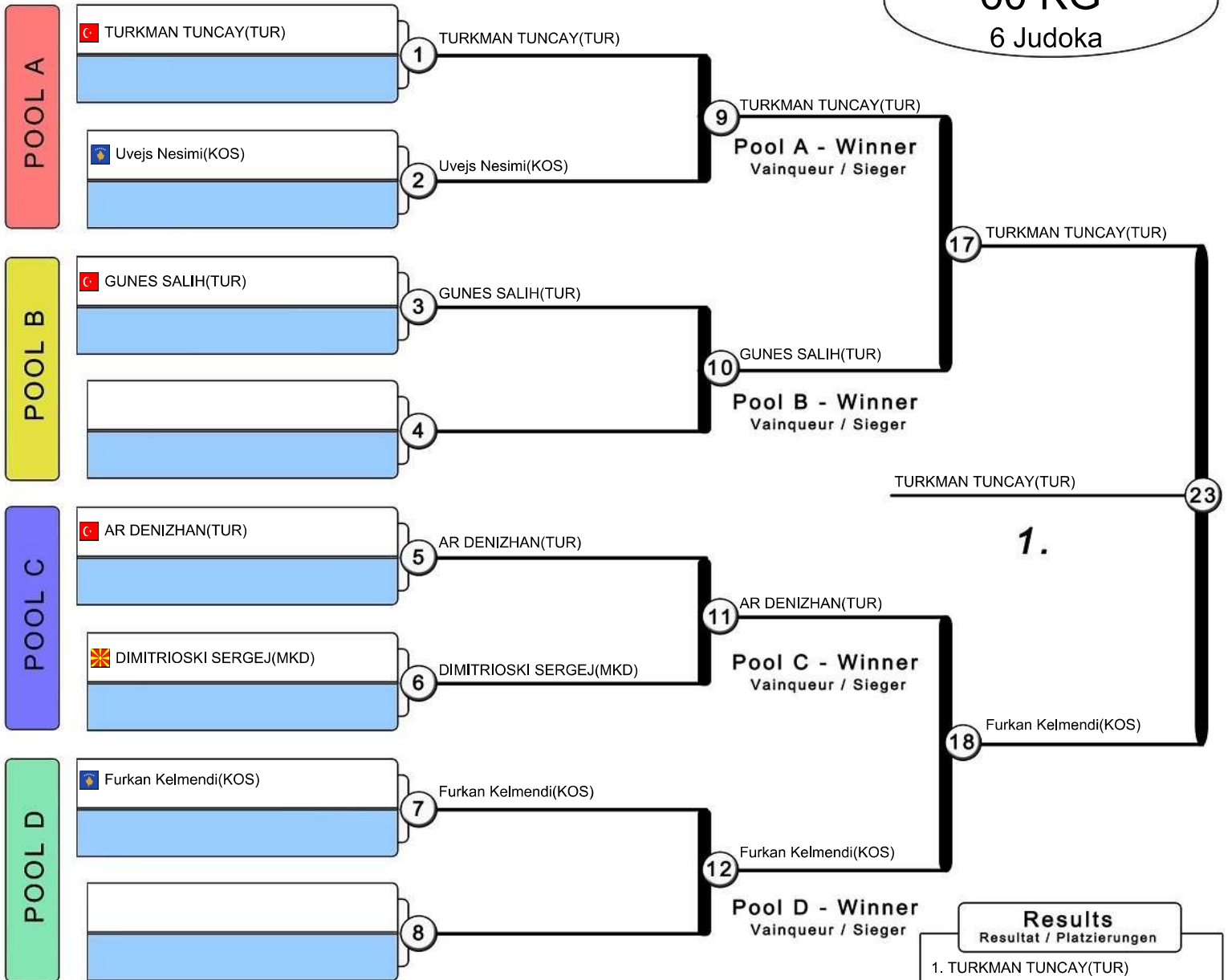

BALKAN JUDO ASSOCIATION
BALKAN JUDO CHAMPIONSHIP For SENIORS
 September 13 - 14, 2025 - PEJA, KOSOVO

60 KG
6 Judoka



- Results**
 Resultat / Platzierungen
1. TURKMAN TUNCAY(TUR)
 2. Furkan Kelmendi(KOS)
 3. Uvejs Nesimi(KOS)
 3. DIMITRIOSKI SERGEJ(NMKD)
 5. GUNES SALIH(TUR)
 5. AR DENIZHAN(TUR)

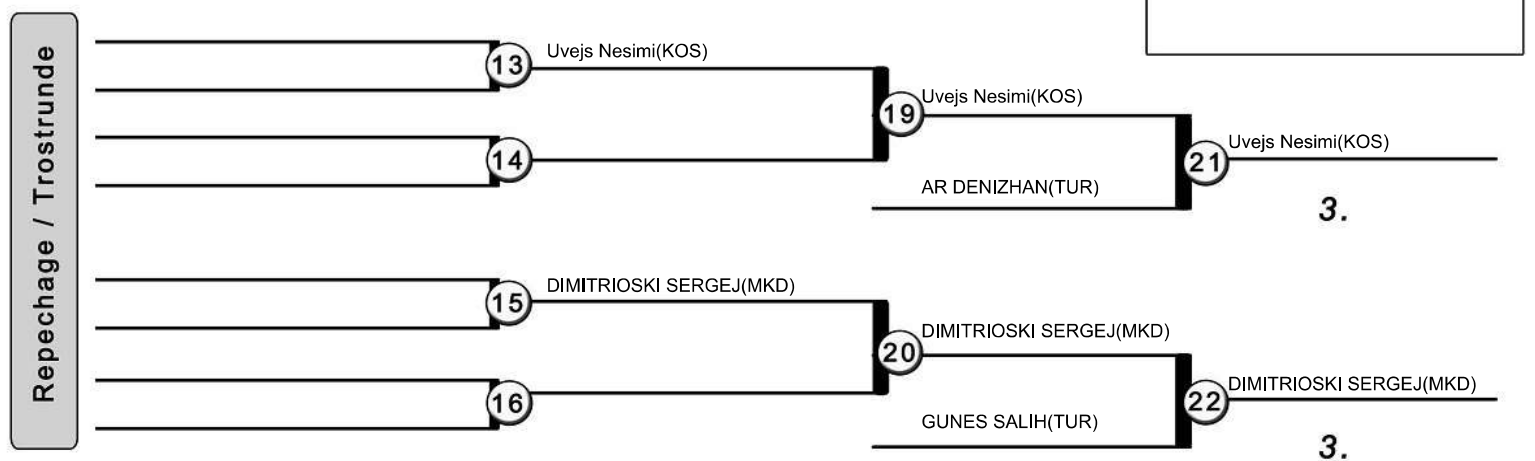



BALKAN JUDO ASSOCIATION
BALKAN JUDO CHAMPIONSHIP For SENIORS
 September 13 - 14, 2025 - PEJA, KOSOVO

66 KG
 10 Judoka

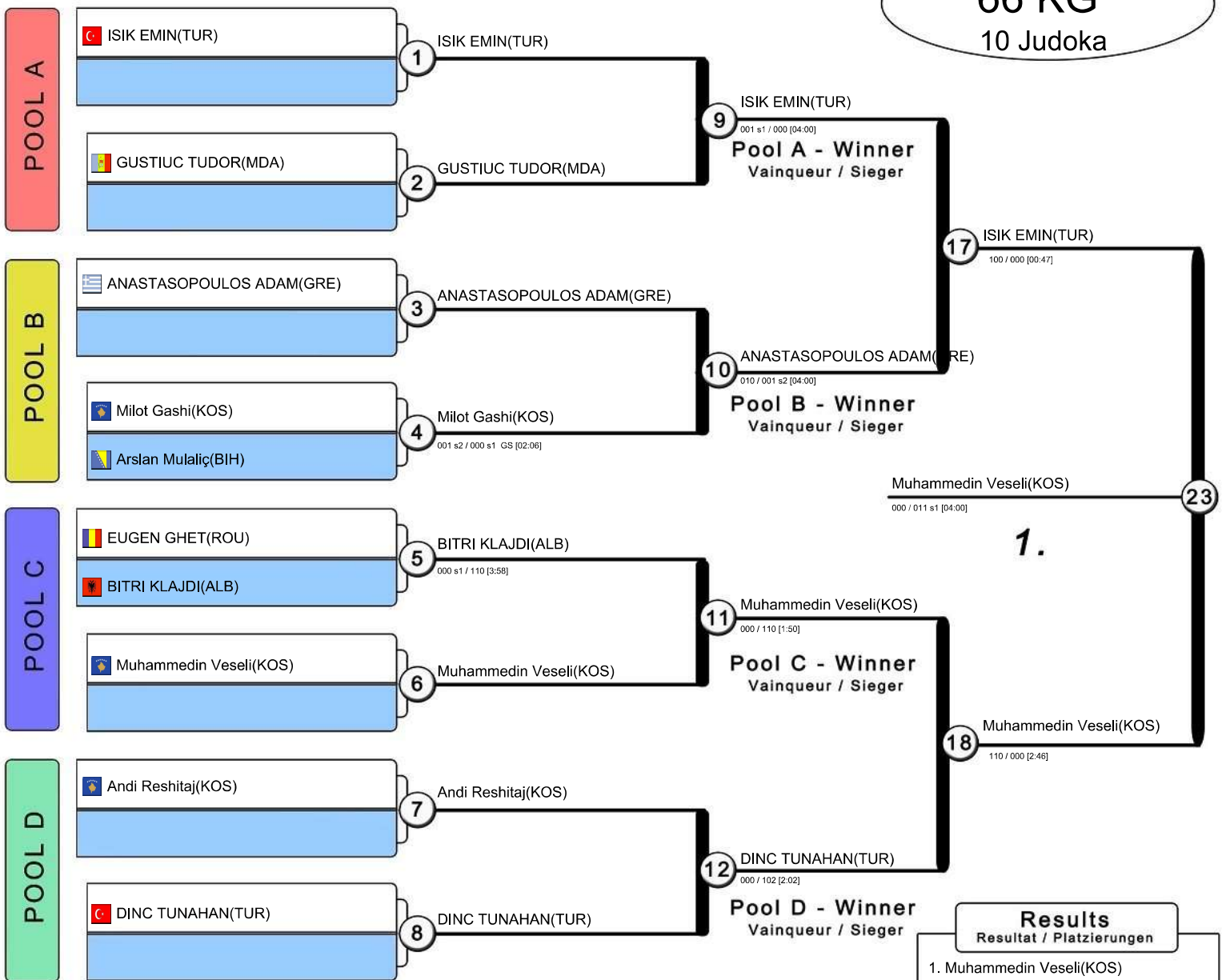

- Results**
 Resultat / Platzierungen
1. Muhammedin Veseli(KOS)
 2. ISIK EMIN(TUR)
 3. BITRI KLAJDI(ALB)
 3. GUSTIUC TUDOR(MDA)
 5. DINC TUNAHAN(TUR)
 5. ANASTASOPOULOS ADAM(GRE)
 7. Milot Gashi(KOS)
 7. Andi Reshitaj(KOS)

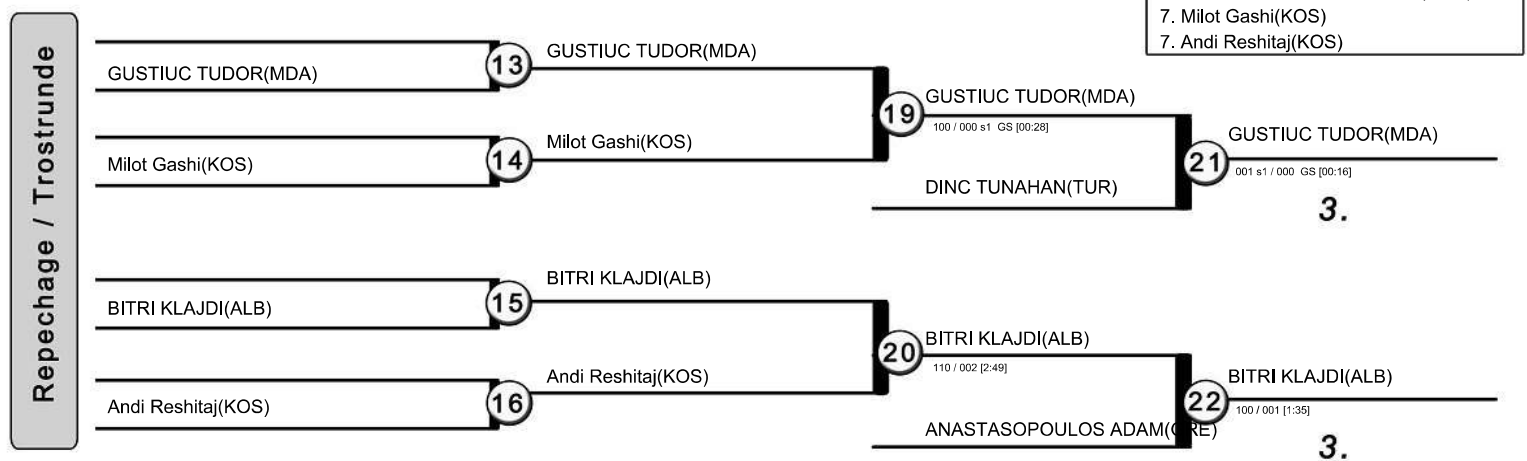



BALKAN JUDO ASSOCIATION
BALKAN JUDO CHAMPIONSHIP For SENIORS
 September 13 - 14, 2025 - PEJA, KOSOVO

73 KG
 13 Judoka

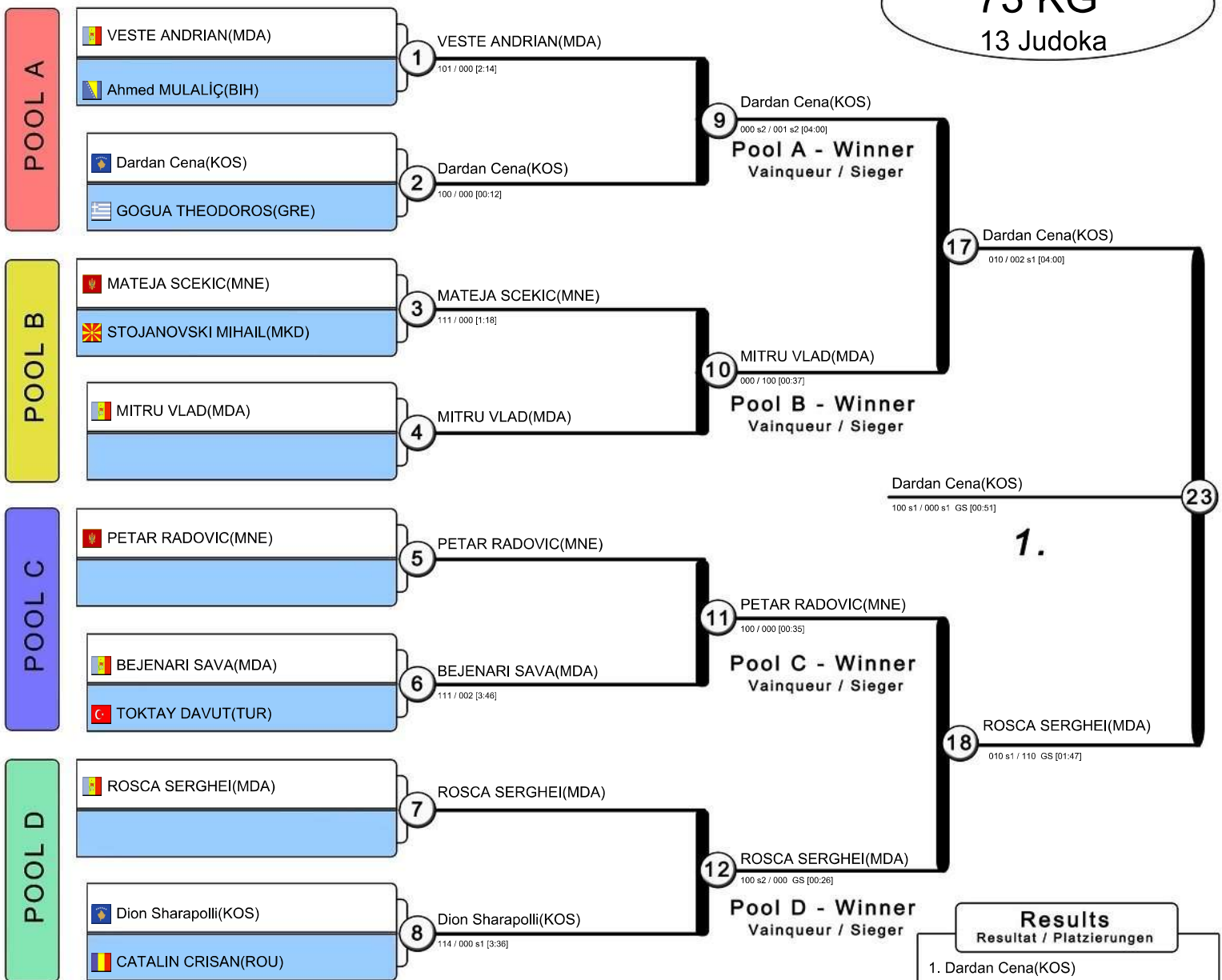

- Results**
 Resultat / Platzierungen
- Dardan Cena(KOS)
 - ROSCA SERGHEI(MDA)
 - MITRU VLAD(MDA)
 - VESTE ANDRIAN(MDA)
 - PETAR RADOVIC(MNE)
 - BEJENARI SAVA(MDA)
 - Dion Sharapolli(KOS)
 - MATEJA SCEKIC(MNE)

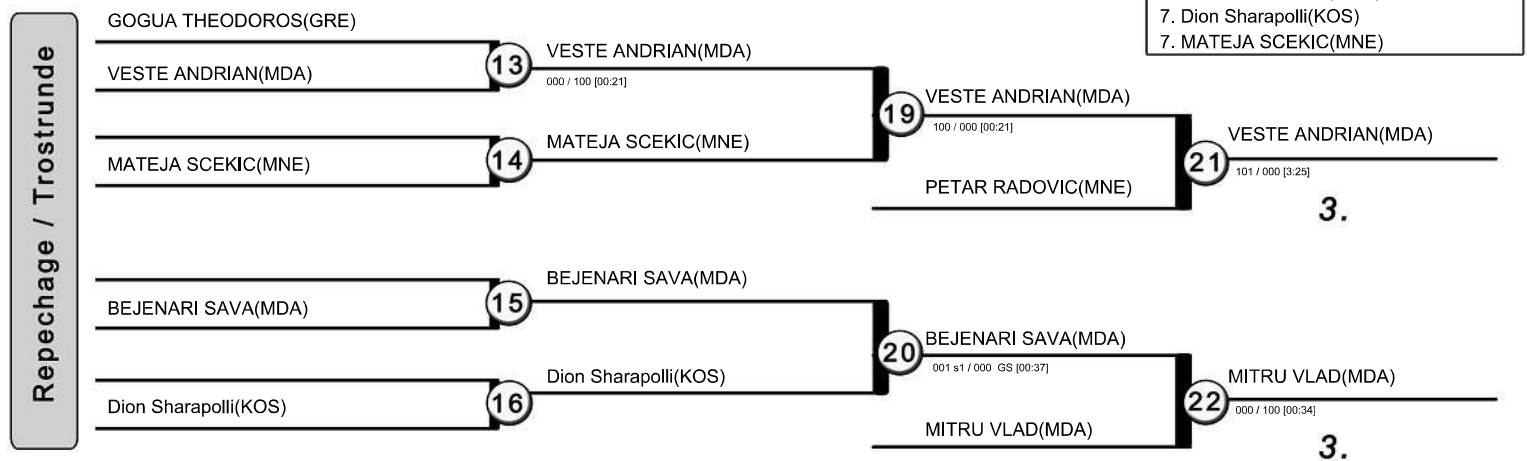



BALKAN JUDO ASSOCIATION
BALKAN JUDO CHAMPIONSHIP For SENIORS
 September 13 - 14, 2025 - PEJA, KOSOVO

81 KG
 11 Judoka

POOL A

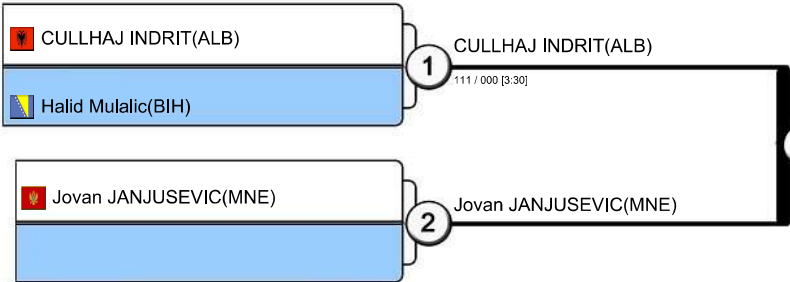

POOL B

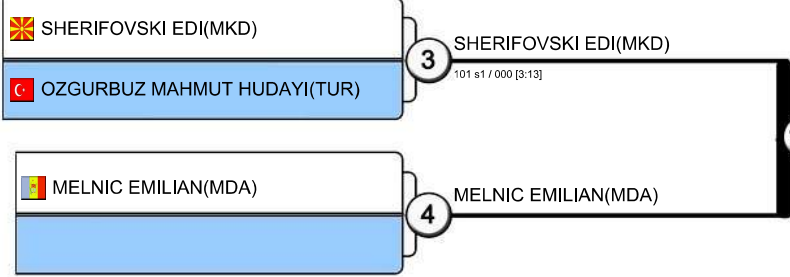

POOL C

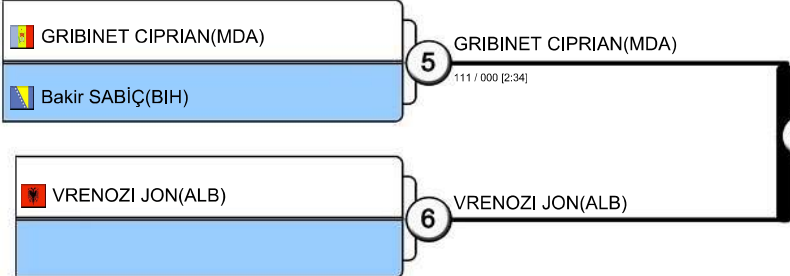

POOL D

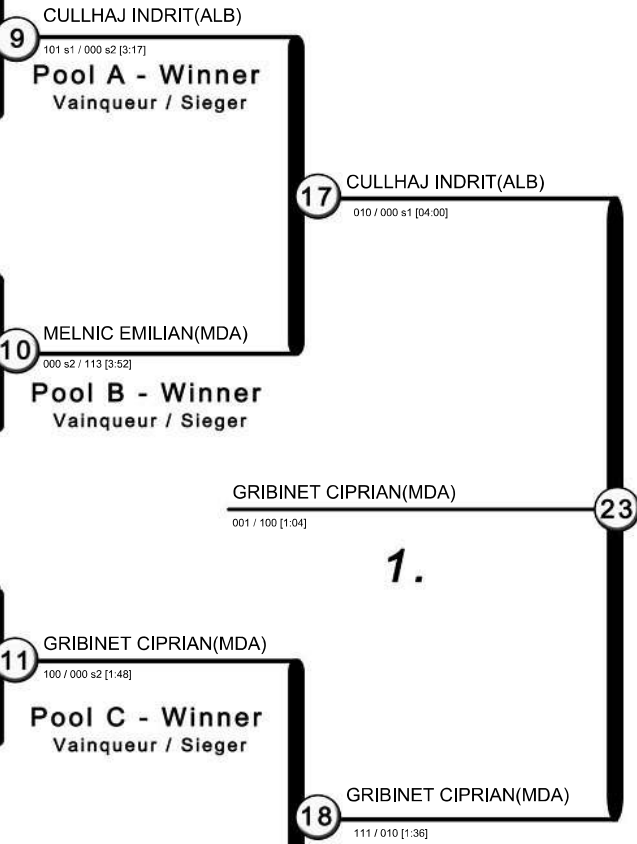
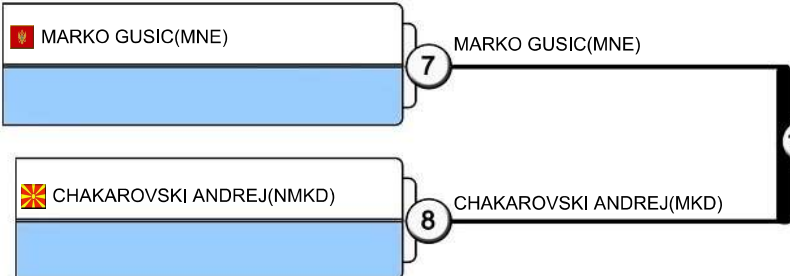

- Results**
 Resultat / Platzierungen
- GRIBINET CIPRIAN(MDA)
 - CULLHAJ INDRIT(ALB)
 - MARKO GUSIC(MNE)
 - VRENOZI JON(ALB)
 - MELNIC EMILIAN(MDA)
 - Halid Mulalic(BIH)
 - SHERIFOVSKI EDI(NMKD)
 - CHAKAROVSKI ANDREJ(NMKD)

Repechage / Trostrunde

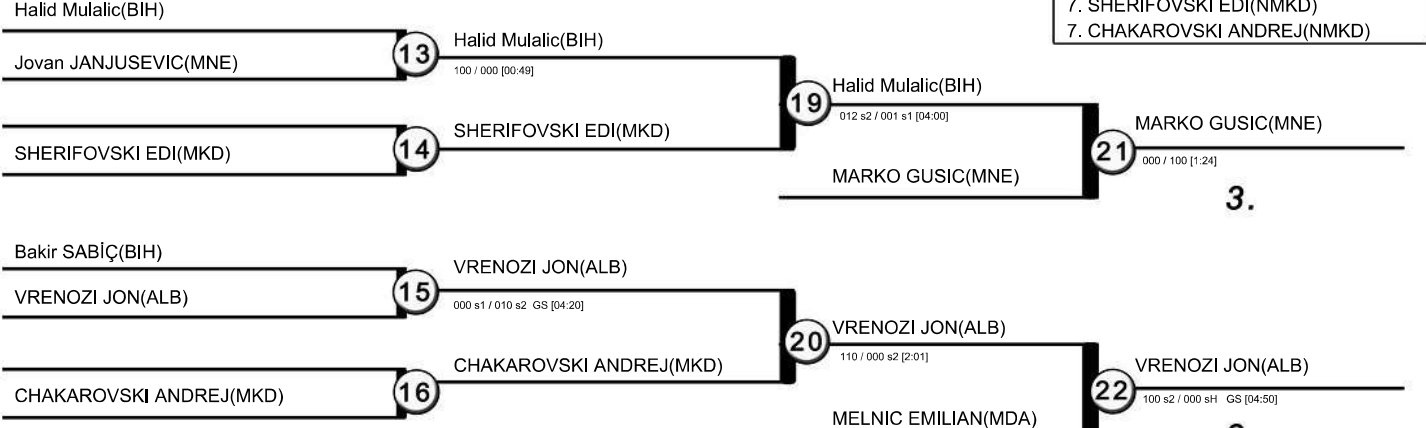



BALKAN JUDO ASSOCIATION
BALKAN JUDO CHAMPIONSHIP For SENIORS
 September 13 - 14, 2025 - PEJA, KOSOVO

90 KG
 10 Judoka

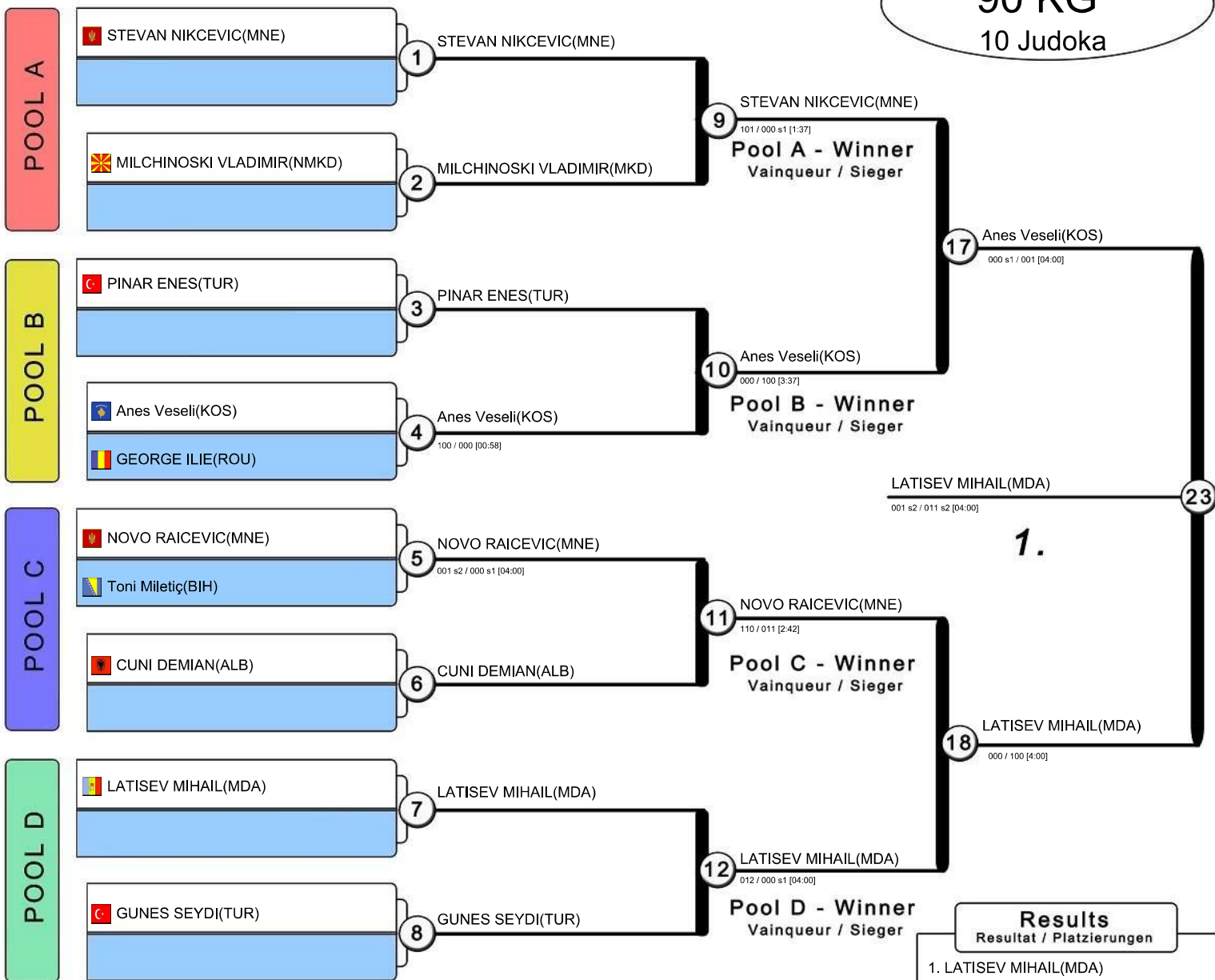

- Results**
 Resultat / Platzierungen
- LATISEV MIHAIL(MDA)
 - Anes Veseli(KOS)
 - Toni Miletic(BIH)
 - STEVAN NIKCEVIC(MNE)
 - GUNES SEYDI(TUR)

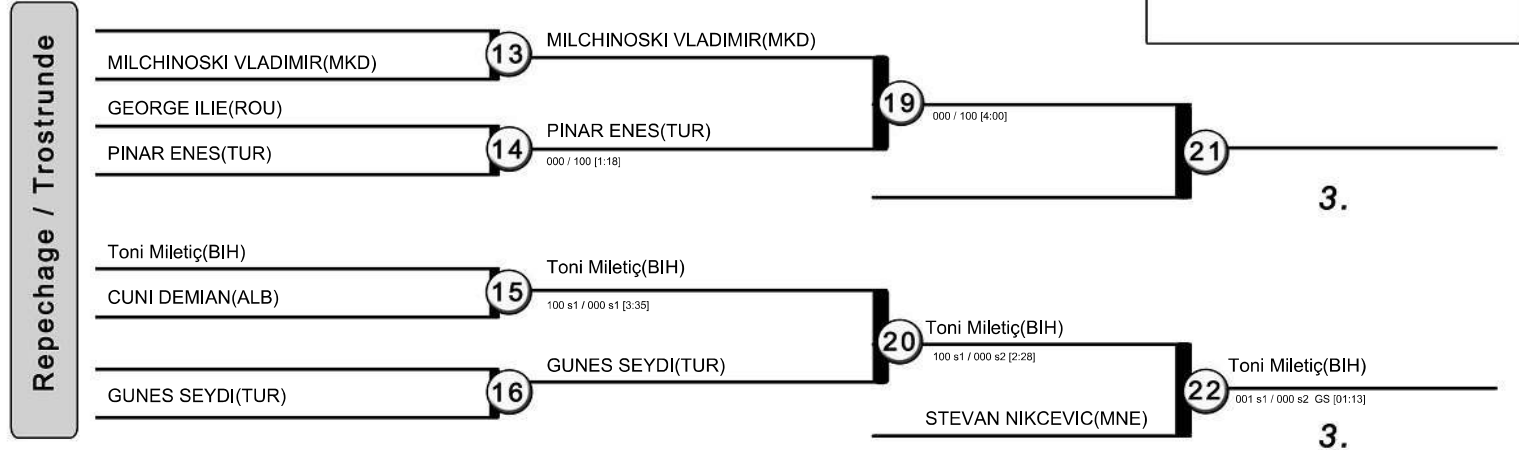



BALKAN JUDO ASSOCIATION
BALKAN JUDO CHAMPIONSHIP For SENIORS
 September 13 - 14, 2025 - PEJA, KOSOVO

100 KG
7 Judoka

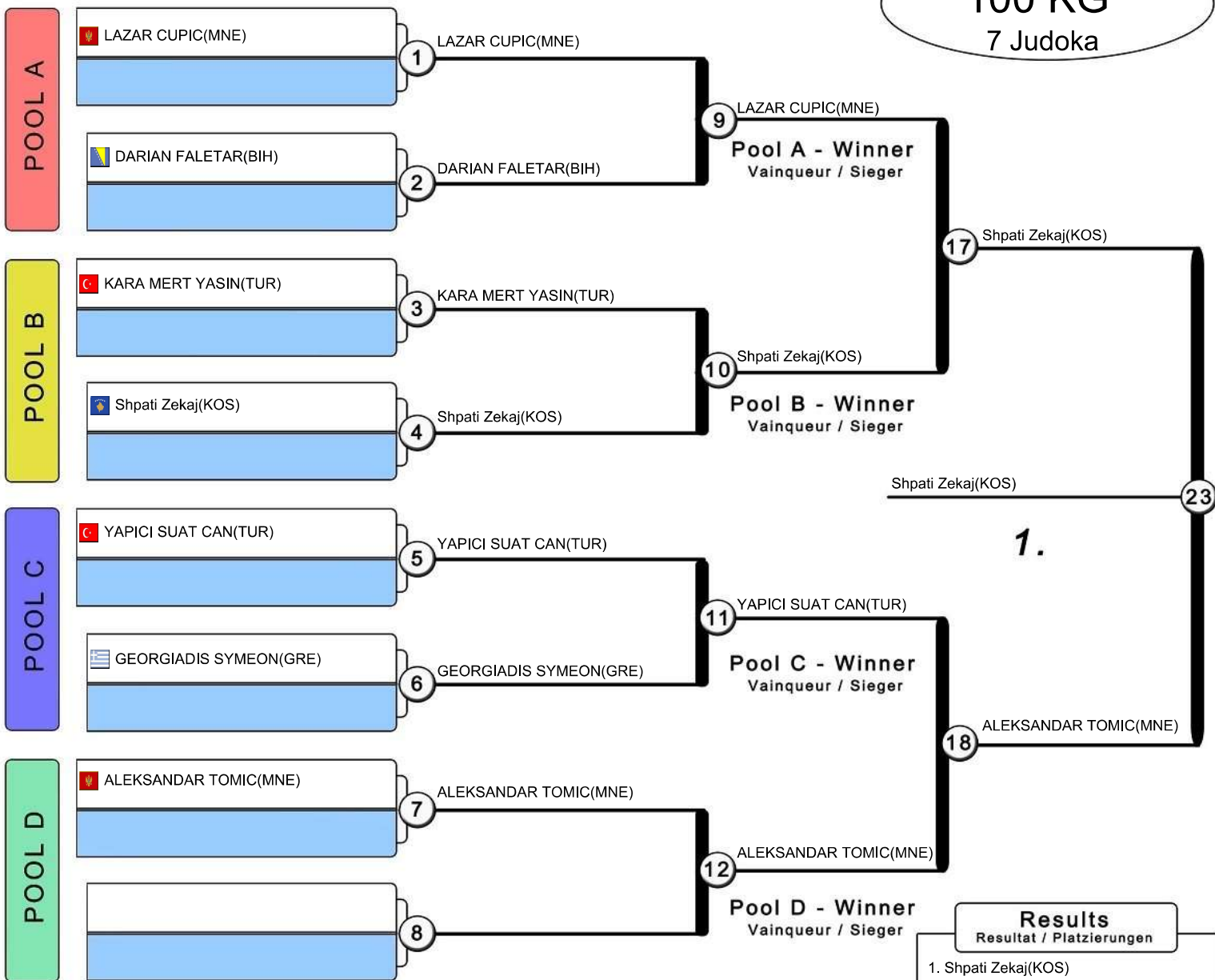

- Results**
Resultat / Platzierungen
1. Shpati Zekaj(KOS)
 2. ALEKSANDAR TOMIC(MNE)
 3. YAPICI SUAT CAN(TUR)
 3. LAZAR CUPIC(MNE)
 5. GEORGIADIS SYMEON(GRE)
 5. KARA MERT YASIN(TUR)
 7. DARIAN FALETAR(BIH)

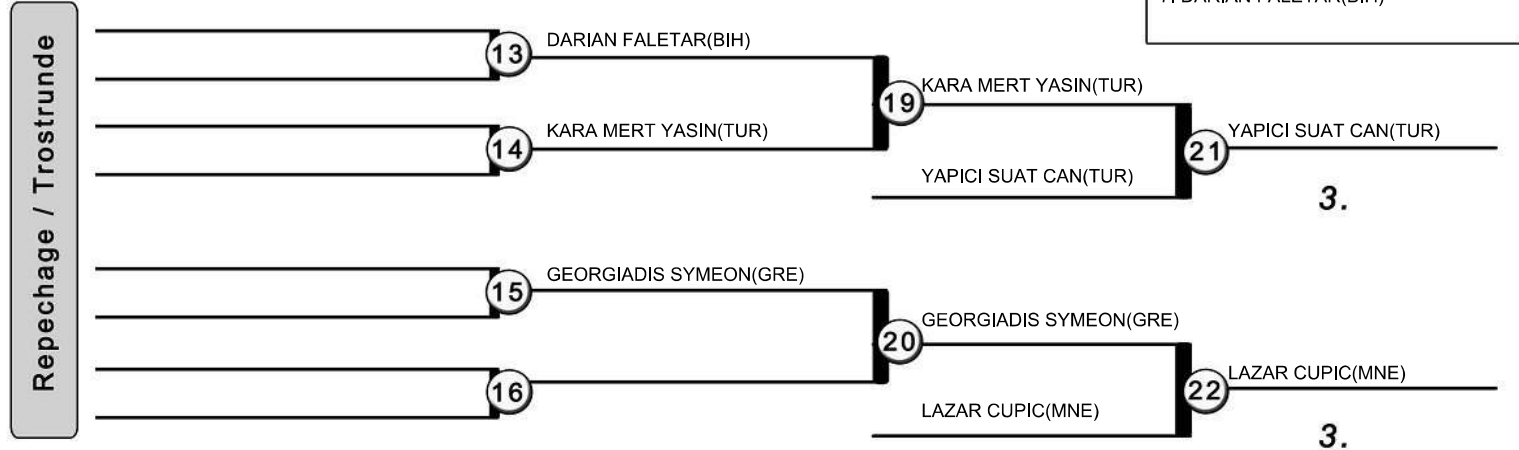



BALKAN JUDO ASSOCIATION
BALKAN JUDO CHAMPIONSHIP For SENIORS
 September 13 - 14, 2025 - PEJA, KOSOVO

+100 KG
 7 Judoka

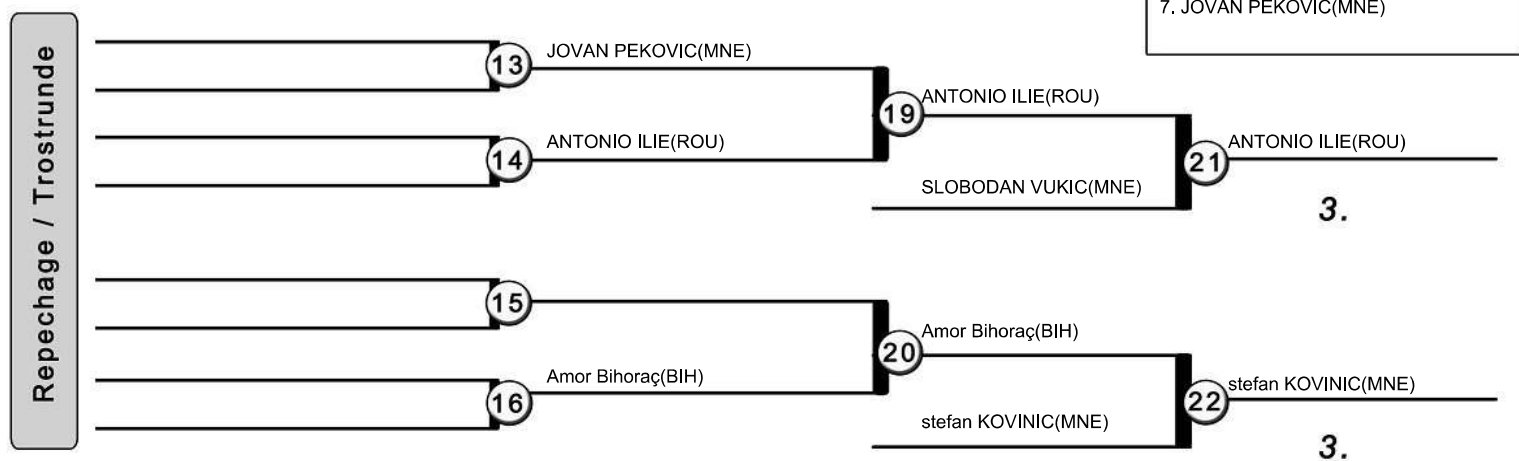
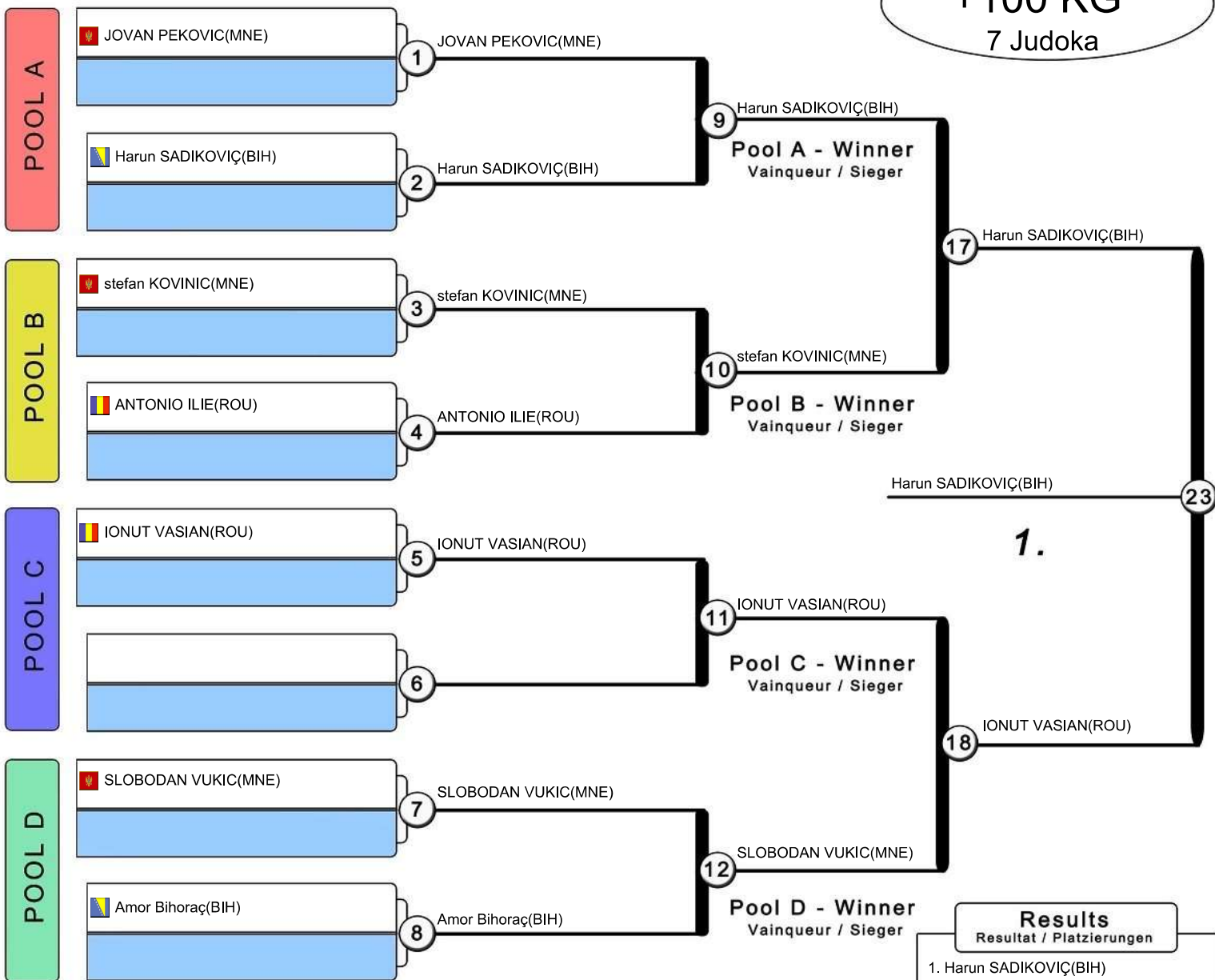



BALKAN JUDO ASSOCIATION
BALKAN JUDO CHAMPIONSHIP For SENIORS
September 13 - 14 , 2025 - PEJA , KOSOVO

48 KG
3 Judoka

		1	2	3	Wins	
1	YILDIRIM SEYMA(TUR)		1 ¹⁰ ₁	1 ¹⁰ ₁	2 ²⁰ ₂	
2	BIRINCI HILAL SEMA(TUR)	0		0	0 ⁰ ₀	
3	Estea Arifaj(KOS)	0	1 ¹⁰ ₁		1 ¹⁰ ₁	

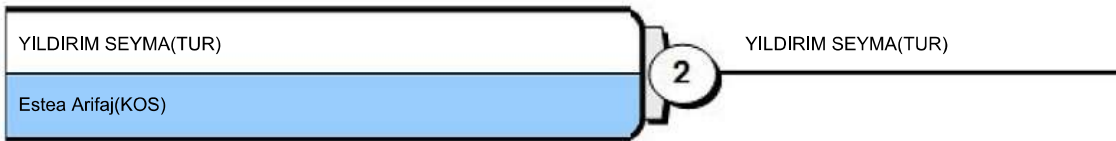

Results
Resultat / Platzierungen

1. YILDIRIM SEYMA(TUR)
2. Estea Arifaj(KOS)
3. BIRINCI HILAL SEMA(TUR)



BALKAN JUDO ASSOCIATION
BALKAN JUDO CHAMPIONSHIP For SENIORS
 September 13 - 14, 2025 - PEJA, KOSOVO

52 KG
 10 Judoka

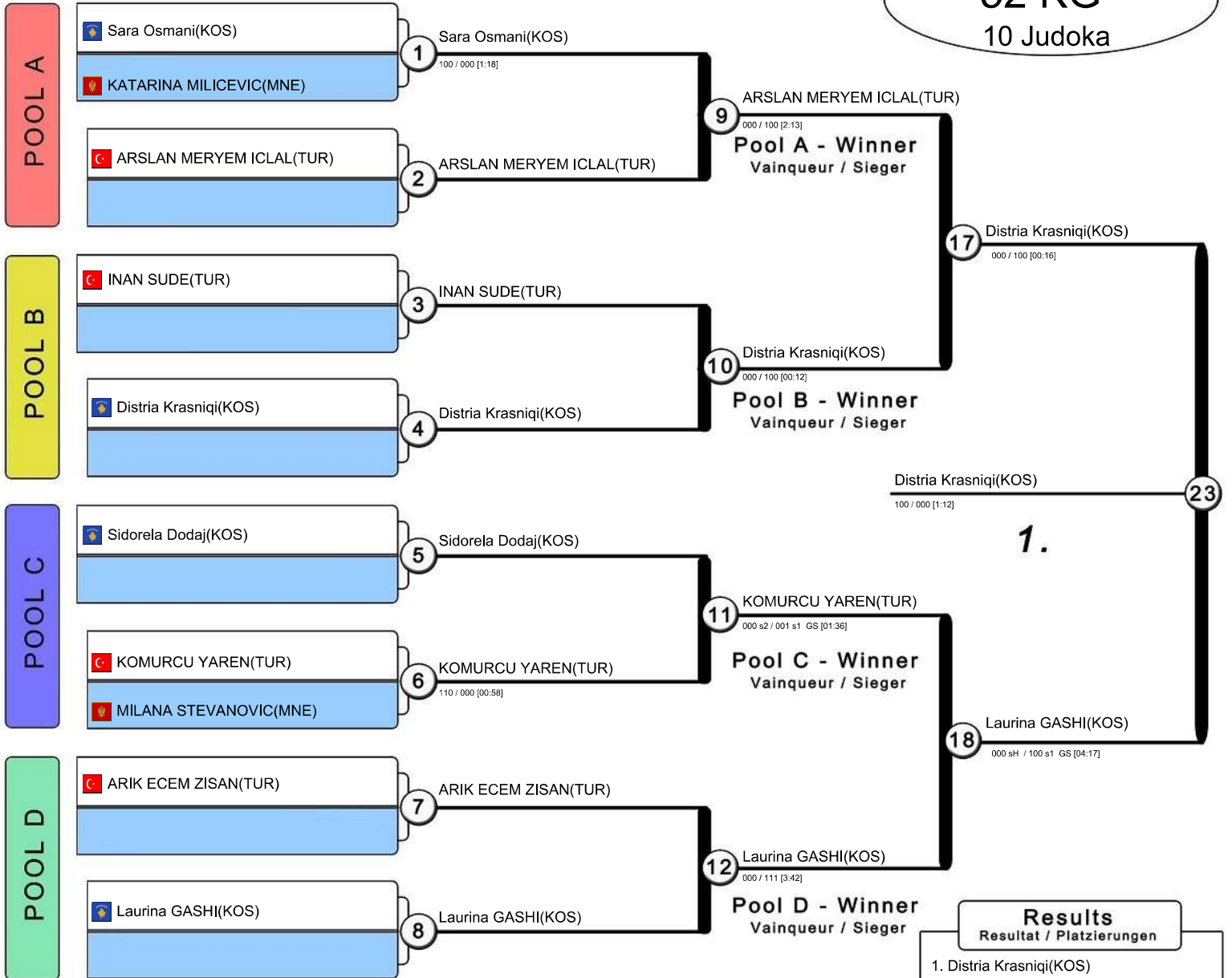

- Results**
 Resultat / Platzierungen
1. Distria Krasniqi(KOS)
 2. Laurina GASHI(KOS)
 3. INAN SUDE(TUR)
 3. ARSLAN MERYEM ICLAL(TUR)
 5. Sidorela Dodaj(KOS)
 5. KOMURCU YAREN(TUR)
 7. Sara Osmani(KOS)
 7. ARIK ECEM ZISAN(TUR)

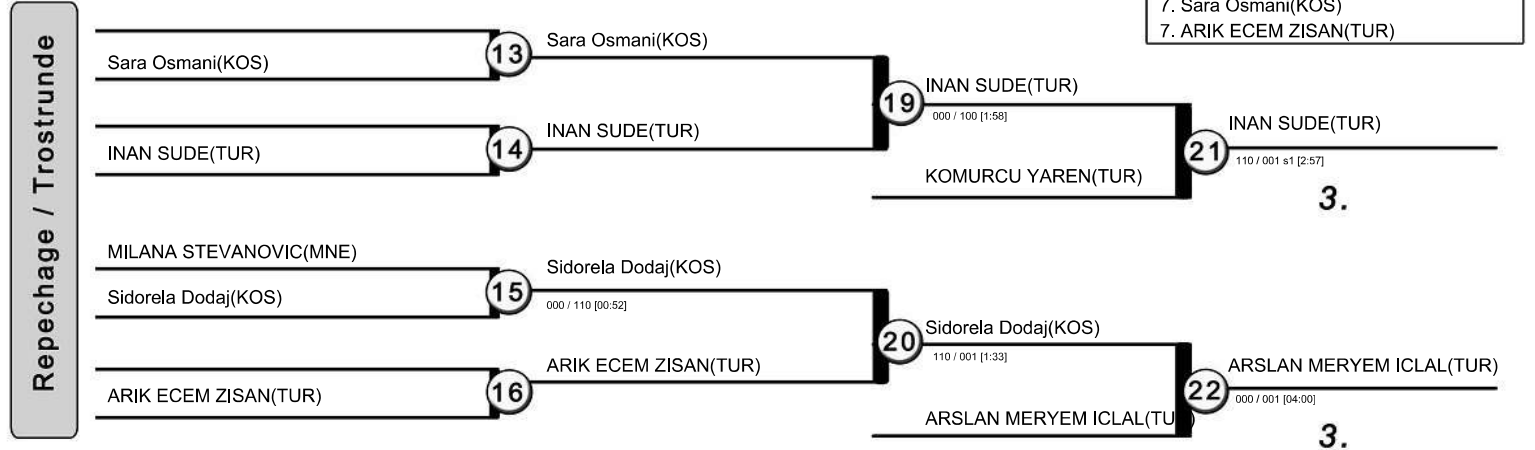



BALKAN JUDO ASSOCIATION
BALKAN JUDO CHAMPIONSHIP For SENIORS
 September 13 - 14, 2025 - PEJA, KOSOVO

57 KG
 9 Judoka

POOL A

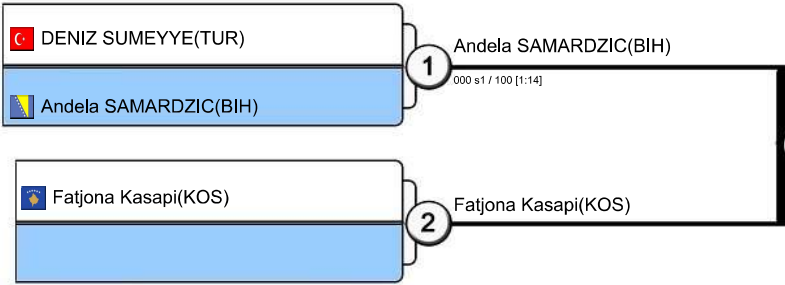

POOL B

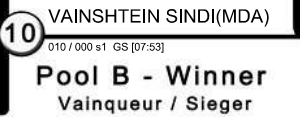
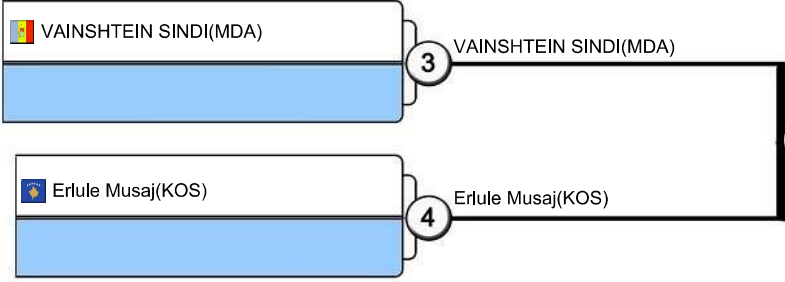

POOL C

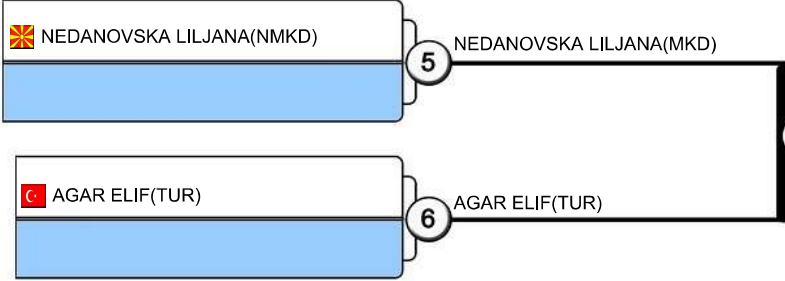

POOL D

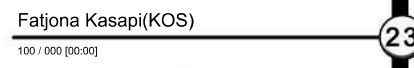
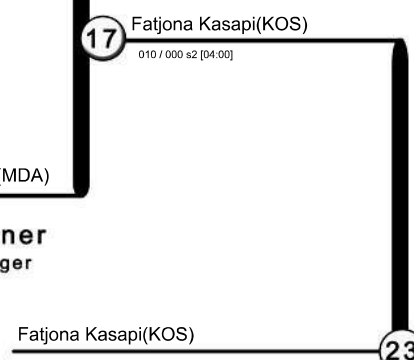
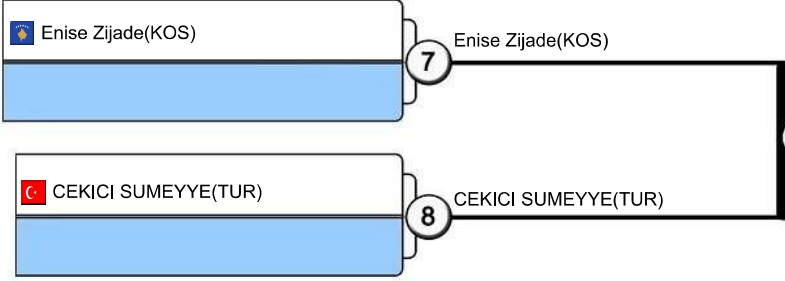

- Results**
 Resultat / Platzierungen
1. Fatjona Kasapi(KOS)
 2. Enise Zijade(KOS)
 3. VAINSHEIN SINDI(MDA)
 3. Andela SAMARDZIC(BIH)
 5. AGAR ELIF(TUR)
 5. CEKICI SUMEYYE(TUR)
 7. NEDANOVSKA LILJANA(NMKD)
 7. Erlule Musaj(KOS)

Repechage / Trostrunde

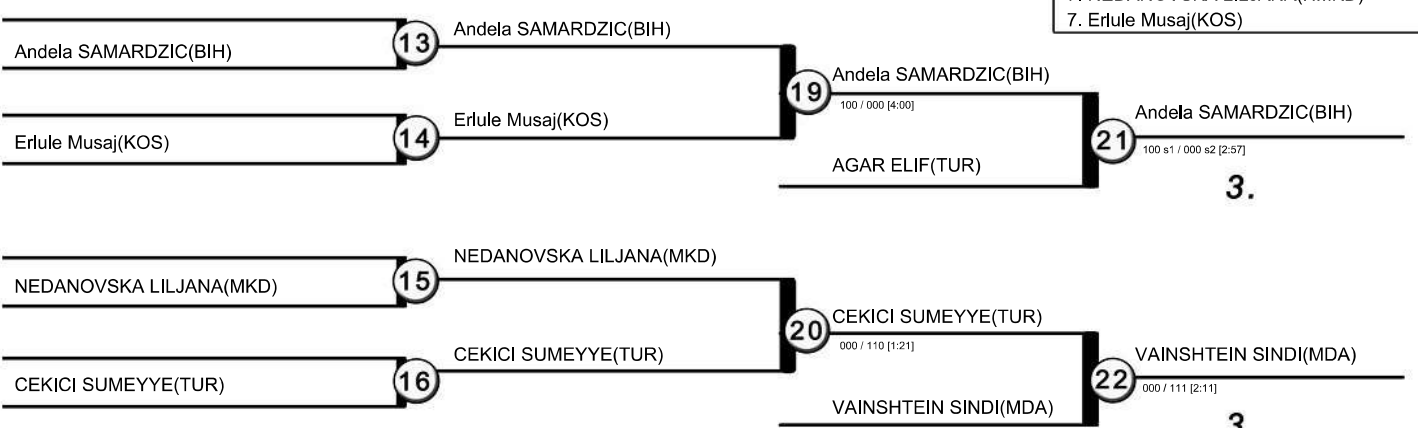



BALKAN JUDO ASSOCIATION
 BALKAN JUDO CHAMPIONSHIP For SENIORS
 September 13 - 14, 2025 - PEJA, KOSOVO

63 KG
 5 Judoka

	1	3	5		
1 Kasandra KOVAČI(ALB)		1 ¹⁰ 1	0		
3 Eljesa Salihu(KOS)	0		0		
5 Dzejla KOZLJAK(BIH)	1 ¹⁰ 1	1 ¹⁰ 1			

	2	4		
2 Krista KOVAČI(ALB)		0		
4 Debora Gjakova(KOS)	0 ¹			

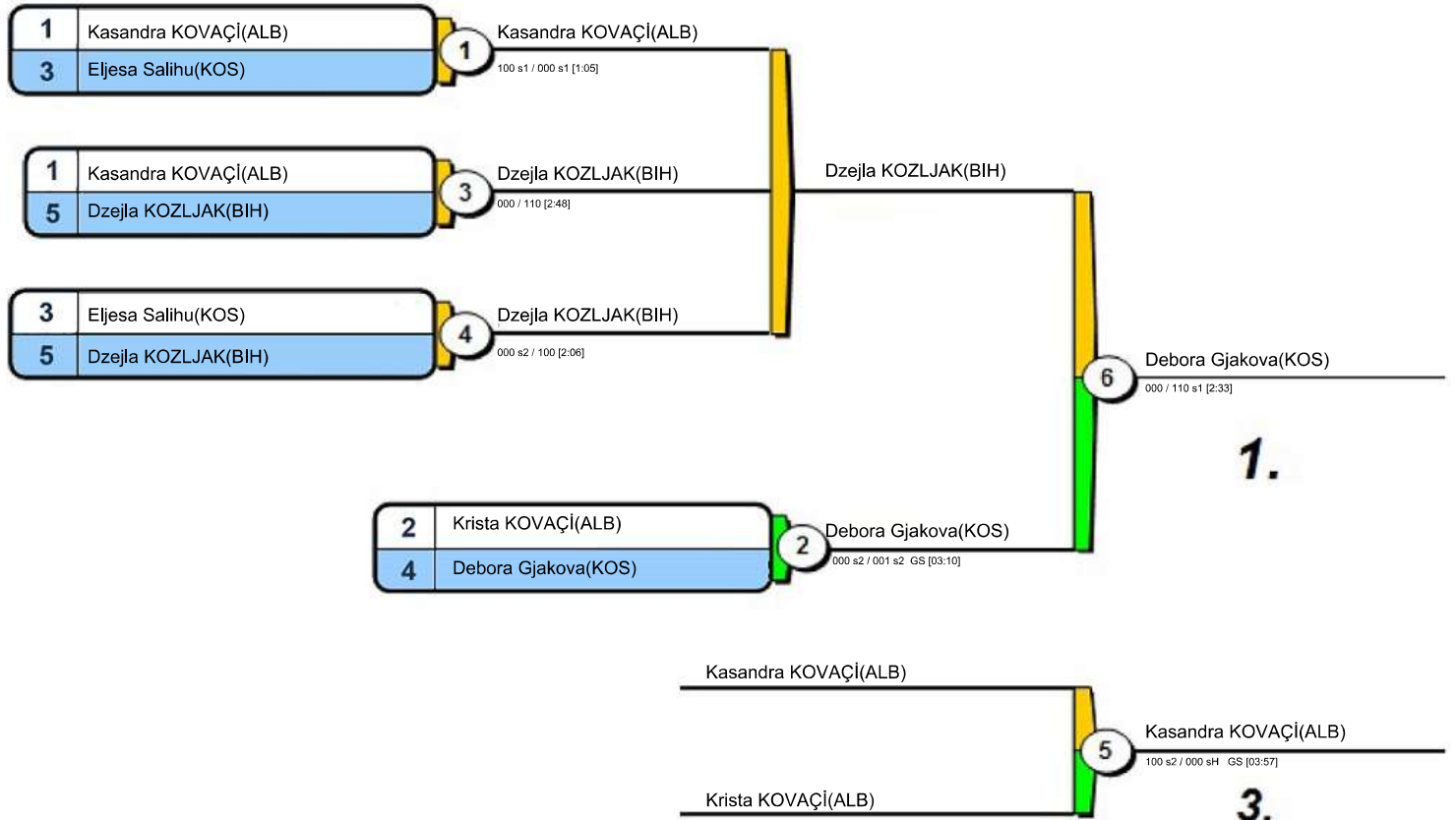

1.

3.

Results

Resultat / Platzierungen

1. Debora Gjakova(KOS)
2. Dzejla KOZLJAK(BIH)
3. Kasandra KOVAČI(ALB)



BALKAN JUDO ASSOCIATION
BALKAN JUDO CHAMPIONSHIP For SENIORS
September 13 - 14 , 2025 - PEJA , KOSOVO

70 KG
2 Judoka

		1	2	3	Wins	
1	KOTO RUMEYSA(TUR)	10 1			10 1	
2	HASANAJ ARBA(KOS)	0			0 0	



Results
Resultat / Platzierungen

1. KOTO RUMEYSA(TURKIYE)
2. HASANAJ ARBA(KOSOVO)



BALKAN JUDO ASSOCIATION
BALKAN JUDO CHAMPIONSHIP For SENIORS
September 13 - 14 , 2025 - PEJA , KOSOVO

78 KG
4 Judoka

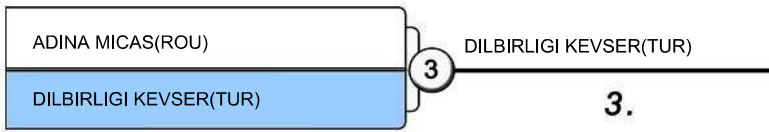
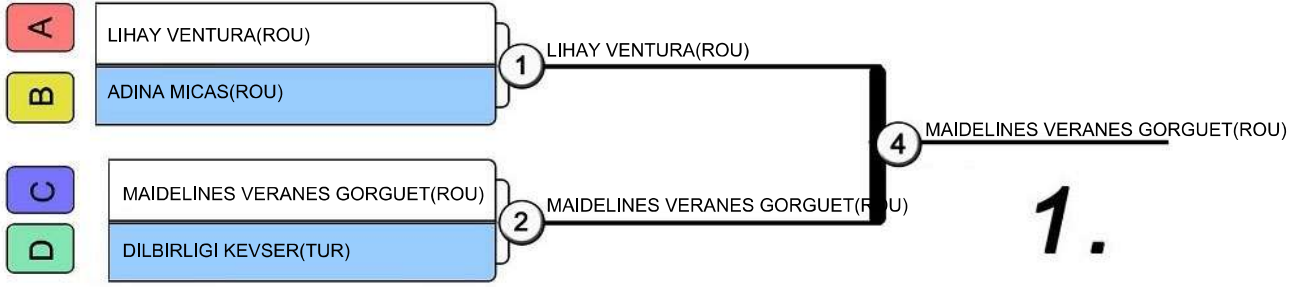

Results
Resultat / Platzierungen

1. MAIDELINES VERANES GORGUET(ROU)
2. LIHAY VENTURA(ROU)
3. DILBIRLIGI KEVSER(TUR)



BALKAN JUDO ASSOCIATION
BALKAN JUDO CHAMPIONSHIP For SENIORS
 September 13 - 14, 2025 - PEJA, KOSOVO

+78 KG
 5 Judoka

	1	3	5		
1 JOVANA MRVALJEVIC(MNE)		1 ¹⁰ ₁	0		
3 Sebina HARACIC(BIH)	0		0		
5 DIACENCO OXANA(MDA)	1 ¹⁰ ₁	1 ¹⁰ ₁			

	2	4		
2 NAJDOSKA ALEKSANDRA (MKD)		0		
4 PAULA PASTIU(ROU)	1 ¹⁰ ₁			

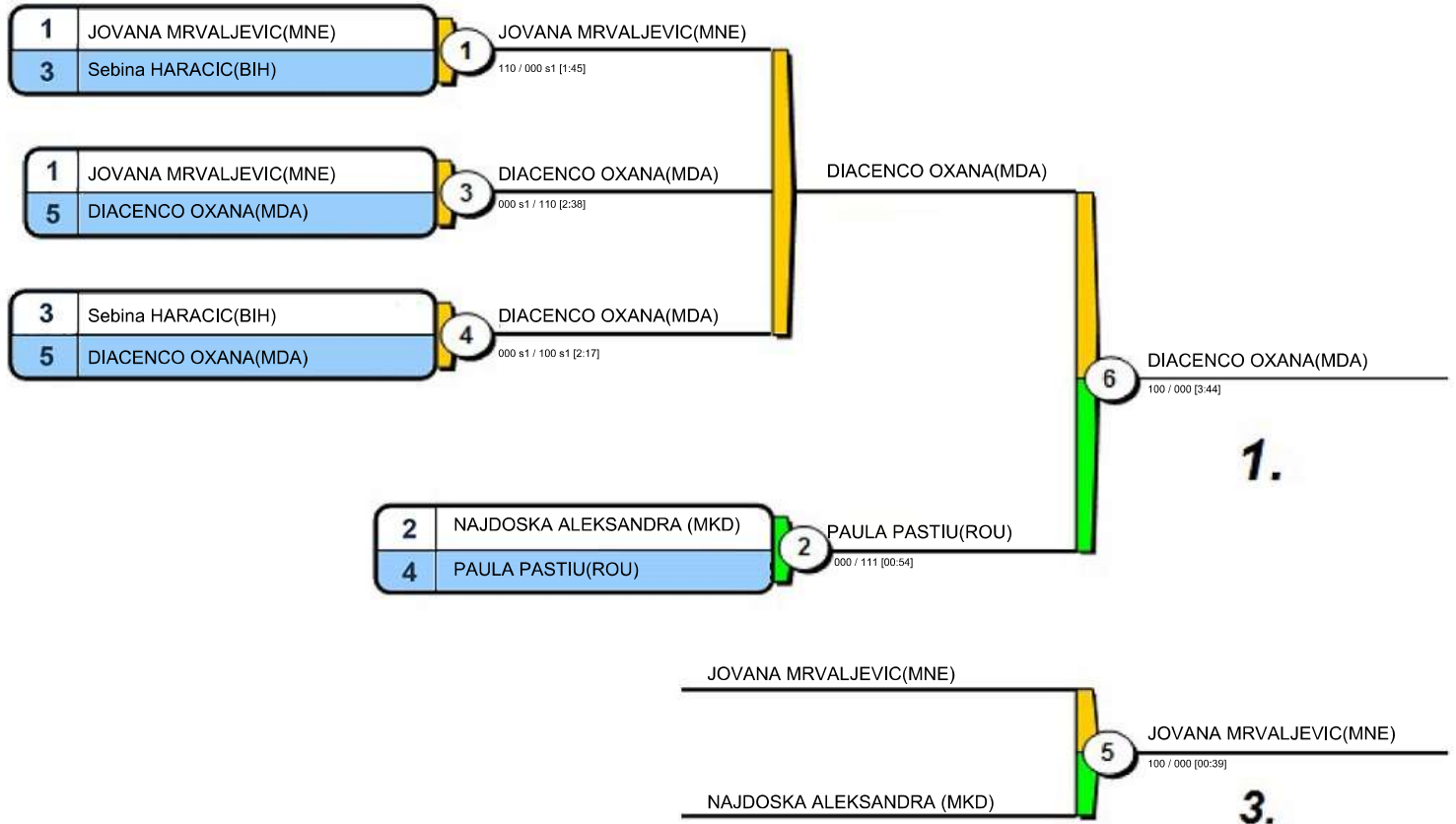

- Results**
 Resultat / Platzierungen
- DIACENCO OXANA(MDA)
 - PAULA PASTIU(ROU)
 - JOVANA MRVALJEVIC(MNE)